

FACTORY AUTOMATION

Graphic Operation Terminal GOT SIMPLE Series

GOT SIMPLE Graphic Operation Terminal



New Version

- Beautiful display, better visibility
- Check your shop floor from a distant location
- Quick startup and adjustments are possible without a PC
- Reduce maintenance time with abundant maintenance features



Automating the World

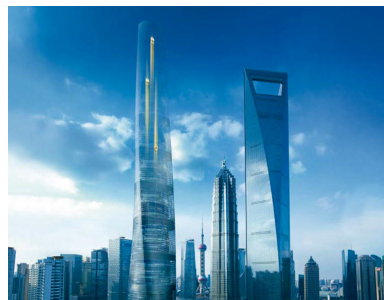

Our Factory Automation business is focused on "Automating the World" to make it a better, more sustainable environment supporting manufacturing and society, celebrating diversity and contributing towards an active and fulfilling role.

Mitsubishi Electric is involved in many areas including the following:

Energy and Electric Systems

A wide range of power and electrical products from generators to large-scale displays.

Electronic Devices

A wide portfolio of cutting-edge semiconductor devices for systems and products.

Home Appliance

Dependable consumer products like air conditioners and home entertainment systems.

Information and Communication Systems

Commercial and consumer-centric equipment, products and systems.

Industrial Automation Systems

Maximizing productivity and efficiency with cutting-edge automation technology.



The Mitsubishi Electric Group is actively solving social issues, such as decarbonization and labor shortages, by providing production sites with energy-saving equipment and solutions that utilize automation systems, thereby helping towards a sustainable society.

INDEX

1. GOT SIMPLE Series	4	1
2. Hardware	6	2
3. GOT SIMPLE Series remote solutions	8	3
4. GOT Drive Control (Inverter) Interactive Solutions	10	4
5. GOT Drive Control (Servo) Interactive Solutions	12	5
6. Reduce design, setup, and maintenance cost	14	6
7. Add value to your installation and machine	18	7
8. Streamlined screen design	20	8
9. Function list	22	9
10. Specifications	26	10
11. Product list	28	11
12. Connectable model list	30	12
13. Support	31	13
14. HMI lineup	32	14

GOT SIMPLE Series opens up new possibilities

1 GOT SIMPLE Series

The screenshot displays the 'Operation monitor' interface on a 7-inch widescreen display. The interface includes the Mitsubishi Electric logo at the top left. The main display area is divided into several sections:

- Top Section:** Features the Mitsubishi Electric logo and the title 'Operation monitor'. Below the title, there are indicators for 'OFF', 'ON', and '120'.
- Left Section:** Contains two large circular gauges. The top gauge shows 'Output Frequency' with a value of 115.6. The bottom gauge shows 'Output Current' with a value of 0.75. To the right of these gauges is a small circular indicator with 'OFF' and 'ON' labels.
- Right Section:** Features a line graph showing a fluctuating signal over time. Below the graph are several control buttons: 'Operation Speed' (Low, Middle, High), 'Rotation Direction' (Forward, Reverse, Stop), 'Frequency Setting' (123), and 'System Status' (Up to Frequency, Instantaneous Power Failure, Frequency Detection, Overload, Alarm).
- Bottom Section:** A navigation bar with buttons for 'TOP', 'Menu', 'Parameter 1', 'Operation Monitor' (highlighted), 'Graph', 'Alarm', 'Help', and 'Reach'.

Dimensions are indicated on the left and bottom of the screen:

- Vertical dimension 1: 214 mm (8.43 inch)
- Vertical dimension 2: 155 mm (6.10 inch)
- Horizontal dimension 1: 206 mm (8.11 inch)
- Horizontal dimension 2: 272 mm (10.71 inch)

7" widescreen GS2107-

Actual size



WTBD-N 10" widescreen GS2110-WTBD-N

GS21

GS2110-WTBD-N	10" widescreen
GS2107-WTBD-N	7" widescreen

WVGA 800 x 480	TFT color LCD 65536 colors	24 V DC
User memory (ROM) 15 MB	User memory (RAM) 64 MB	Memory Upgrade

Built-in interfaces

Ethernet (1 port)	RS-232	RS-422/485
Rear face USB (device)	SD memory card interface	



GS21 model

Simple model for simple applications

10" widescreen, GS2110-WTBD-N



7" widescreen, GS2107-WTBD-N



Beautiful text display and easy usability

Windows fonts and outline fonts look smoother and more beautiful through anti-aliasing.

Additionally, the VNC server function enables remote monitoring of equipment, enhancing work efficiency.

* To design screens of the upgraded GS21 model, it is required to use GT Works3 Version 1.320J or later.

Item	Specifications	
	GS2110-WTBD-N	GS2107-WTBD-N
Display	10" widescreen, TFT color LCD, 65536 colors	7" widescreen, TFT color LCD, 65536 colors
Resolution	WVGA	
Backlight	White LED	
Memory capacity	ROM: 32 MB (User memory: 15 MB) RAM: 128 MB (User memory: 64 MB*) Upgrade	
Standard interface	Ethernet, RS-232, RS-422/485 USB device (USB Mini-B): 1 channel (USB1.1 (Full-Speed 12 Mbps)) SD memory card interface	

* Up to 64 MB of memory for operation (RAM) can be used by writing BootOS with a version of the basic system application of 01.55.*** or later. Also, please design the GOT screen using GT Works3 Version 1.320J or later.

Enabling remote maintenance VNC server function

If a problem occurs in a remote location, it is easy to monitor the GOT from your office and take corrective actions quickly.

* A license (GT25-VNCSKEY-□) is required separately.

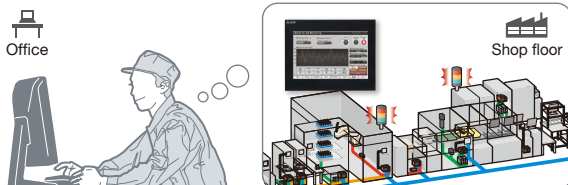

Support for RS-485 connection

A common interface for RS-422 and RS-485 connections is available. Temperature controllers and MODBUS® devices can be connected.



Displaying text beautifully Ver.UP

Anti-aliasing for Windows fonts is now supported. Smooth and beautiful lettering enhances the visibility of the screen design.

Fonts that can be anti-aliased:

- Windows fonts NEW
- Outline fonts

* To perform anti-aliasing processing on Windows fonts, please design the GOT screen using GT Works3 Version 1.320J or later.

In the case of Windows font (Arial)

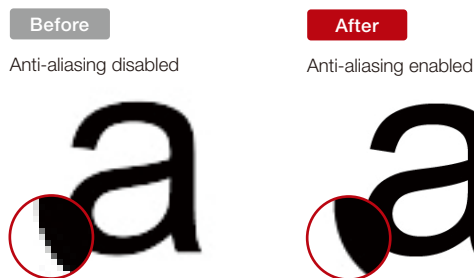

Compared to when anti-aliasing is disabled...
the edges are smoother.

Enhanced traceability for easy troubleshooting Operation log function

The operation information, such as the "what, when, and how" of an operation performed can be recorded in chronological order in an SD memory card and checked on a PC. Use of the operation log function combined with the operator authentication function records additional information of "who" performed the operation.

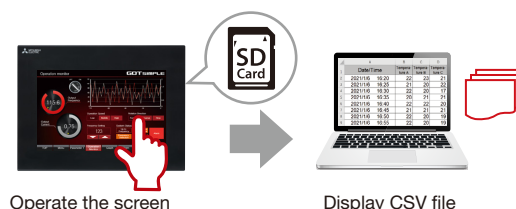

GS21 model external appearance [front face/rear face] * The example pictures shows the 10 inch model.



1 GOT front face

IP65F rating provides reliable protection in industrial environments.

2 Ethernet interface

Use Ethernet to simultaneously connect up to two types of industrial devices such as programmable controller, inverter, and servo, each using a different communication driver.

CC-Link IE Field Network Basic compatible devices can also be connected.

3 RS-232 interface

Connect to various industrial devices, barcode readers and serial printers.

4 RS-422/485 interface

Connect to various industrial devices such as programmable controller, servo, inverter, barcode readers, temperature controller, and MODBUS[®] compatible devices.

5 USB interface: device (USB Mini-B)

Connect to a PC and transfer data.

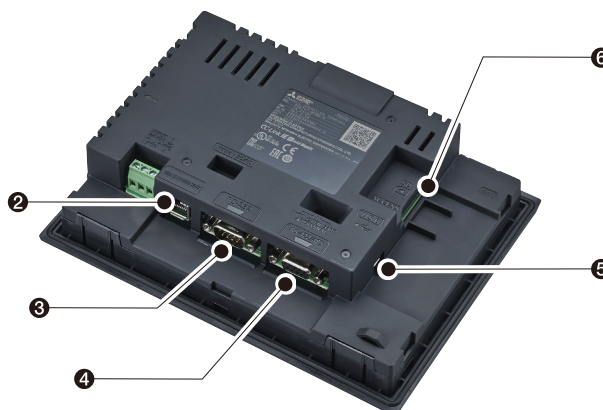

6 SD memory card interface

Save large volumes of data, including alarms and logging data.

Features

Safety precautions

When iQ Monozukuri products or the VNC Server function are used to perform remote control of control equipment, the field operator may not notice the remote control, possibly leading to an accident. In addition, a communication delay or interruption may occur depending on the network environment, and remote control of control equipment cannot be performed normally in some cases. Before using these functions to perform remote control, fully grasp the circumstances of the field site and ensure safety.

Monitor from remote locations

VNC server function ^{*1*2}

Monitor production remotely

Remotely view the GOT screen from information devices such as a PC and tablet.

No dedicated screens are required.

*1 A separate license (GT25-VNCSKEY-□) is required.

*2 One client can connect to one GOT at the same time.

On a PC in your office

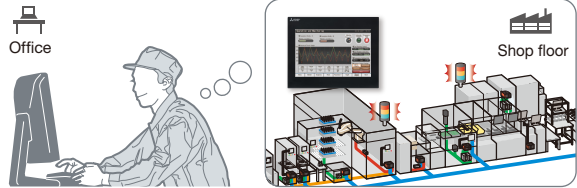

Same functions as GOT

Utility functions including the backup/restoration function and the device monitor are also supported on computers and tablets.

On a tablet from a remote location

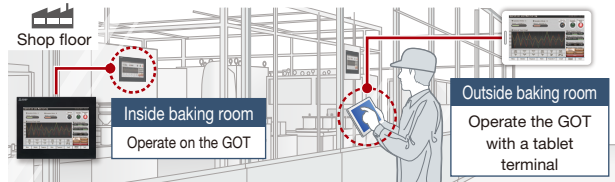

Safe operation avoiding simultaneous operations

Authorization function prevents accidents that might be caused by simultaneous operations by multiple operators.

With operating authority
● Input operations enabled

Without operating authority
✗ Input operations disabled

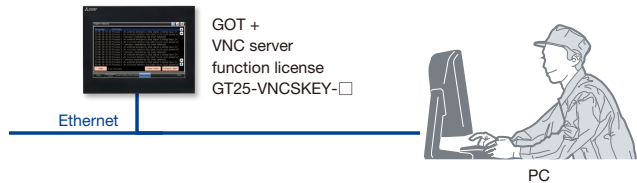

Application examples

Check the alarm without visiting the shop floor

From a remote office, you can easily monitor the alarms. Check the alarm and corrective actions in detail, and you can solve the problem quickly and reduce downtime.

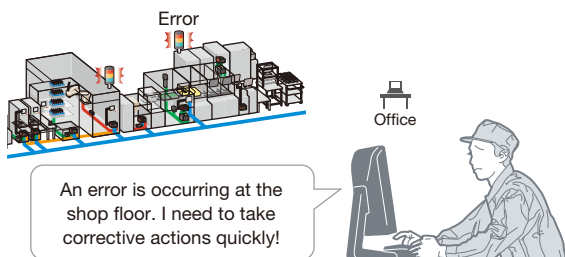

Easily startup large equipment

When starting up and adjusting large-scale equipment, you may have to work away from the GOT.

You can now check the GOT screen using a tablet from a remote location so that all the work can be done by a single operator efficiently.



Specification details and restrictions

For the supported connection types and necessary option devices, please refer to the Graphic Operation Terminal GOT2000 Series/GOT SIMPLE Series Catalog (L(NA)08270ENG) or the relevant product manual.

iQ Monozukuri Process Remote Monitoring*1

Easily monitor multiple devices from a remote office

IoT technologies can be easily introduced to the shop floor, and the information of multiple equipment can be collected, visualized, and managed collectively. Manufacturing process and productivity of the whole production can be improved by analyzing the data displayed on GT SoftGOT2000². The operation status of the shop floor and the information such as operation logs and alarms can be collected from each device via an onsite GOT.

*1 iQ Monozukuri Process Remote Monitoring application package is required separately. For more details, please refer to the iQ Monozukuri Process Remote Monitoring catalog (L(NA)08674ENG).

*2 A license key (GT27-SGTKEY-U) is required separately.

Easily implement production visualization system

The template project for GT SoftGOT2000 makes it easy to startup systems.

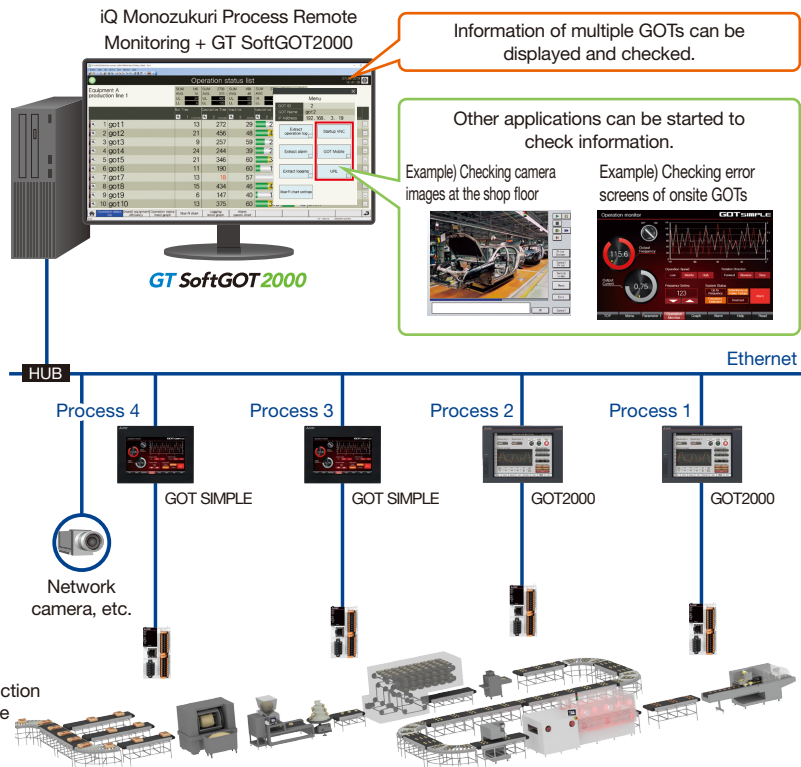

Share the information of the shop floor with pictures and text



Pocket GOT mobile app: Working memo function (Interaction function with the iQ Monozukuri Process Remote Monitoring)

By installing the Pocket GOT mobile app on a mobile terminal, working memos can be created to share the information such as the daily check results of on-site equipment and the status report at the error occurrence. The working memos can save text, pictures taken, and images saved in the mobile terminal. The created working memos can be sent and saved to the connected GOT. iQ Monozukuri Process Remote Monitoring collects the working memos saved in the GOT, allowing you to check them collectively on a PC and to create reports for each date, time, and place.

* Pocket GOT can be used on iPhone, iPad **NEW**, or Android™ devices.

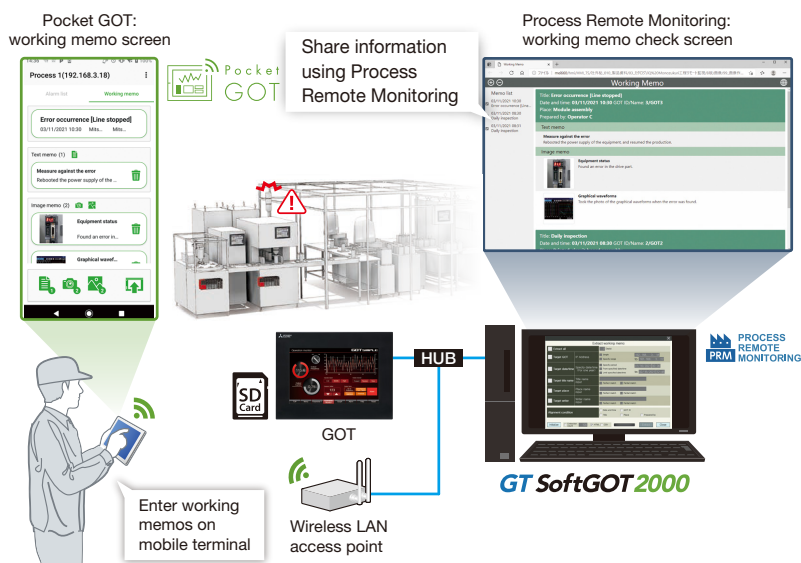

Recommended

GOT Drive Control Inverter Interactive Solutions



GOT SIMPLE + INVERTER
Graphic Operation Terminal

For the details, please refer to the GOT2000 Series Drive Control (Inverter) Interactive Solutions catalog (L(NA)08572ENG).



With GOT, the inverter's parameters can be adjusted with the control panel closed

Parameter settings (simple mode)

Use the GOT on the front of the control panel to adjust the inverter's simple mode parameters. The parameter names can be confirmed on a list, so the required parameters can be easily found and set.

Parameter Setting screen¹⁾

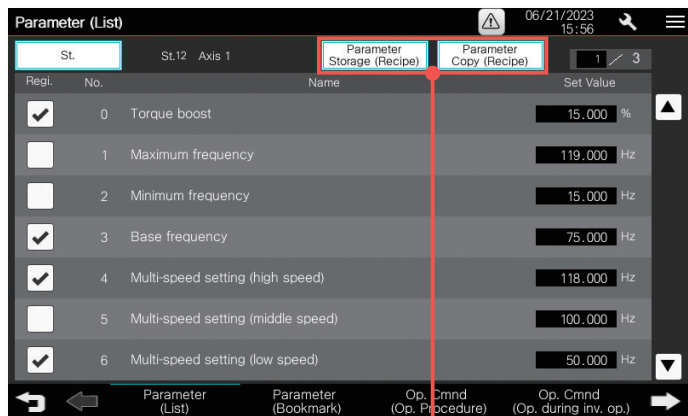

Back up (save) or restore (write) parameters as a recipe file when necessary.

With GOT, the inverter's parameters can be monitored in a batch with the control panel closed

Batch monitor

The inverter's current values such as the output frequency, output current, and output voltage can be monitored with the GOT without preparing the PC or directly confirming the inverter.

Batch Monitor screen^{*1}

No.	Name	Present Value	No.	Name	Present Value
1	Output Frequency	123.45 Hz	11	Converter Output Voltage Peak Value	1234.5 V
2	Output Current	1234.56 A	12	Output Power	1234.56 kW
3	Output Voltage	1234.5 V	13	Load Meter	123.4 %
4	Frequency Setting Value	123.45 Hz	14	Motor Excitation Current	1234.56 A
5	Speed/Machine Speed	12345 r/min	15	Cumulative Energization Time	12345 h
6	Motor Torque	123.4 %	16	Actual Operation Time	12345 h
7	Converter Output Voltage	1234.5 V	17	Motor Load Factor	123.4 %
8	Regenerative Brake Duty	123.4 %	18	Cumulative Power	12345.67 kW
9	Electronic Thermal O/L Relay Load Factor	123.4 %	19	Torque Command	123.4 %
10	Output Current Peak Value	1234.56 A	20	Torque Current Command	123.4 %

With GOT, the replacement timing of the inverter's components can be displayed and predictive maintenance can be performed

Inverter life diagnosis

GOT can be used to monitor the operation status of the inverter's components (main circuit capacitor, control circuit capacitor, etc.) and confirm the replacement timing. Perform predictive maintenance by replacing parts before the inverter fails.

Inverter Life Diagnosis screen^{*1}

Alarm	Name	Life	Remarks
	Main Circuit Capacitor life (Standard model /IP55 compatible model)	100 %	The last measured value is displayed. When the value is 85% or less, it is recommended to replace the capacitor.
	Main Circuit Capacitor estimated residual life(Standard model /IP55 compatible model)	100 %	Even when the power supply cannot be turned OFF, the remaining life of the main circuit capacitor can be estimated without stopping the operation.
	Control Circuit capacitor life	100 %	10% or less is a guideline for replacement.
	Inrush current limit circuit life (Standard model /IP55 compatible model)	100 %	10% or less is a guideline for replacement.
	Power cycle life	100.00 %	Degree of deterioration of the inverter module. When the value is 15% or less, it is recommended to replace it.

*1 Parameters and devices to be monitored can be set and displayed on a screen. These are screen creation examples.

Recommended

GOT Drive Control

Servo

Interactive Solutions



The GOT Drive easily visualizes the servo system status to realize speed up of the system startup and improve predictive maintenance and troubleshooting.

Adjust servos without a PC

One-touch tuning function

Just a single touch on the switch on the GOT screen to perform adjustment work, which is difficult without experience. You can adjust servo amplifier automatically by selecting from three response modes.

One-touch tuning screen¹⁾

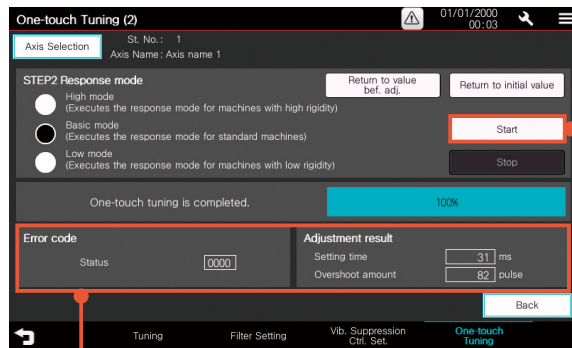

Adjustment results are shown

Just a single touch on the switch

Tuning function

After one-touch tuning, to obtain higher performance, you can perform fine tuning of gain parameters, machine resonance suppression filter, and vibration suppression control parameters in the tuning screen.

Tuning screen¹⁾

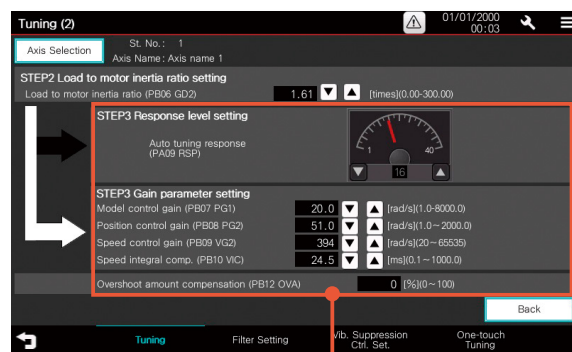

Perform fine tuning of gain parameters, tuning response, and overshoot amount.

Predict machine deterioration and improve system predictive maintenance without a PC

Machine diagnosis function

You can use GOT to display the estimation values (machine friction, torque vibration, etc.) collected by the machine diagnosis function of the servo amplifier and predict the deterioration of the machine.

Machine diagnosis screen^{*1}

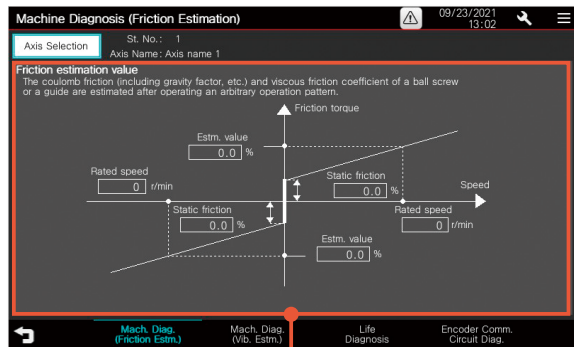

Displays the estimated value upon completion of the machine diagnosis.

Supports predictive maintenance functions of servo amplifiers

Life diagnosis function

Check cumulative operation time, on/off counts of inrush relay on GOT. In addition, replacement timing of servo amplifier components (capacitor, relay) can be displayed on the GOT.



Periodic check

Life diagnosis screen^{*1}

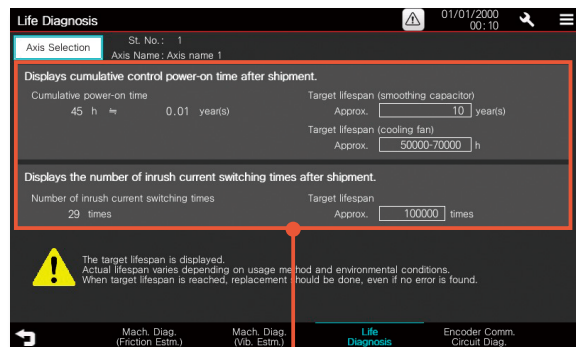

Check the smoothing capacitor energization time or the inrush relay on/off times at a glance.

^{*1} The GOT SIMPLE Series offers sample screens for MR-JE-□A, MR-JE-□B, and MR-JET-□G connections. The sample screens shown are for MR-JET-□G. They differ from those for MR-JE-□A and MR-JE-□B.

Reduce design, setup, and maintenance cost

Reduce mass production installation setup costs

Start from SD memory card

Transfer the project data and all the necessary system data to make a GOT operate to an SD memory card in advance.

Then the GOT can be used just by inserting them. Useful for replacement or maintenance of GOT.

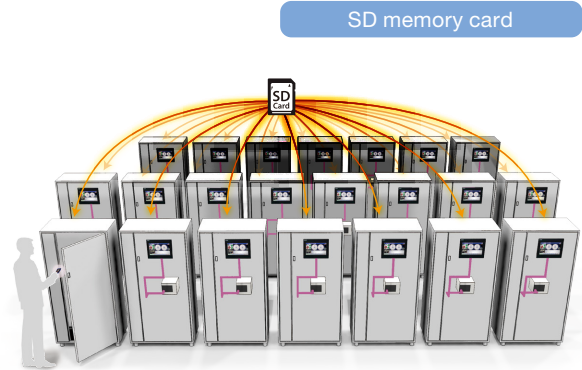

SD memory card

Industrial devices data collection

Logging function

GOT manages the data of all connected industrial devices. The data can be collected at any arbitrary timing and can be used for data analysis and feedback.

Point

The collected data can be displayed as a graph on the GOT, making it easy to understand temperature changes and other status updates at a glance.

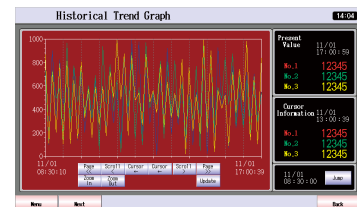
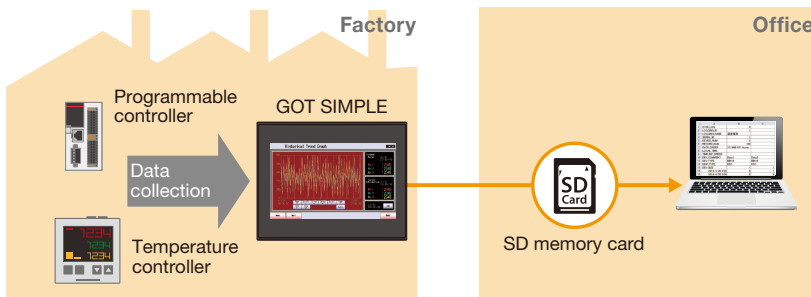

Historical trend graph display

Date	No.	No.	No.	No.	No.	No.
2014/07/31 17:30:30	12345	12345	12345	12345	12345	12345
2014/07/31 17:30:30	12345	12345	12345	12345	12345	12345
2014/07/31 17:30:30	12345	12345	12345	12345	12345	12345
2014/07/31 17:30:30	12345	12345	12345	12345	12345	12345
2014/07/31 17:30:30	12345	12345	12345	12345	12345	12345
2014/07/31 17:30:30	12345	12345	12345	12345	12345	12345
2014/07/31 17:30:30	12345	12345	12345	12345	12345	12345
2014/07/31 17:30:30	12345	12345	12345	12345	12345	12345
2014/07/31 17:30:30	12345	12345	12345	12345	12345	12345

Historical data list display

Recommended

Backup important programs

Backup/Restoration function

Programs of the programmable controller can be replaced even without a PC. When the programs and parameters are backed up to GOT^{*1}, the data and machine operation can instantly be restored even if an unexpected failure occurs.



*1 A separate SD memory card is required.

*2 For details on connectable devices, please refer to the GOT SIMPLE Series User's Manual.

Useful

Setup and modification on-site

FA transparent function

Set up and modify devices without changing cable connections.

USB device

RS-232

Ethernet

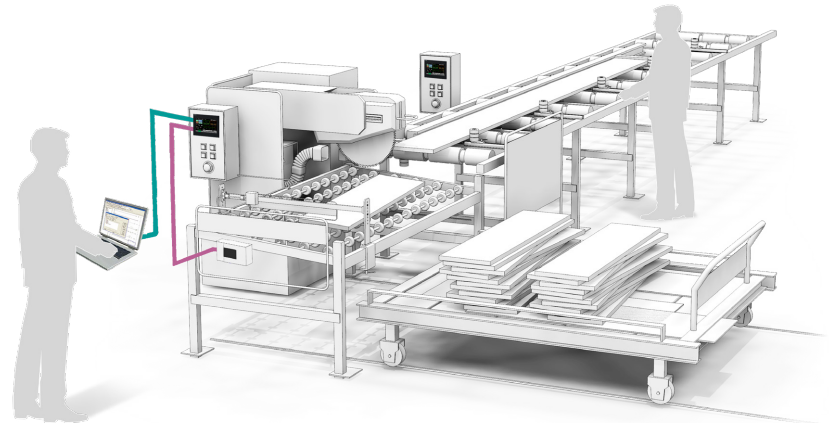

The GOT acts as a transparent gateway to enable programming, startup, and adjustment of Mitsubishi Electric industrial devices.

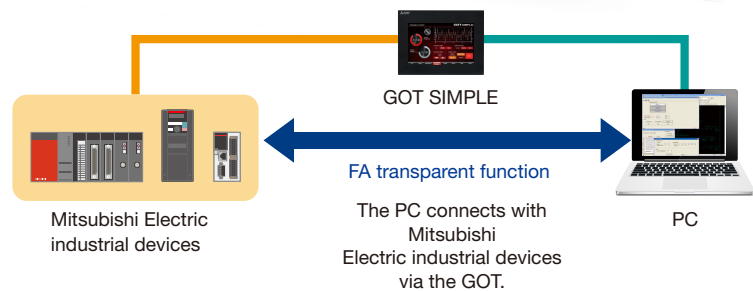

Remote maintenance

Ethernet connection

Office PC can connect to GOT on the factory floor for maintenance via Ethernet.

With Ethernet, it is possible to connect a system of mixed vendors and models, expanding the possibilities at the factory floor.

In addition, Ethernet printers*1 are supported so that the data (such as reports and screen images) can be printed by an Ethernet printer on the network, thus reducing hardware cost.

*1 For the connectable printers, please refer to the Technical Bulletin "List of Valid Devices Applicable for GOT2000 Series and GOT SIMPLE Series (for Overseas)" (GOT-A-0160).

Ethernet

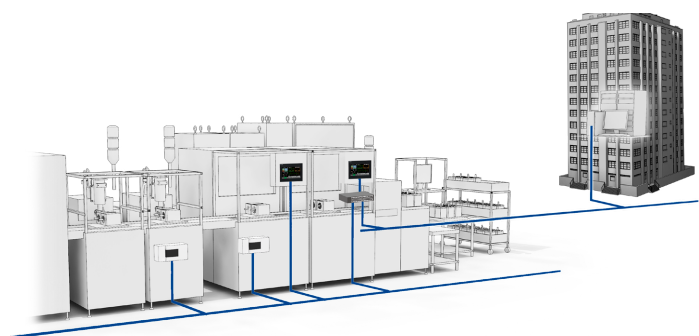

[Connection example]

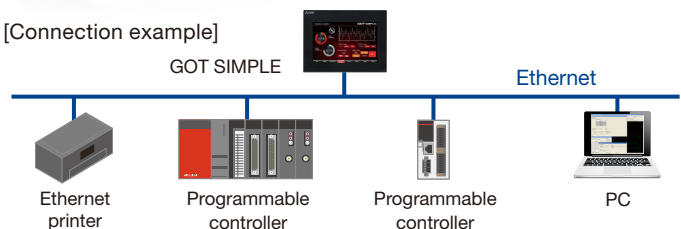

Features

Use GOT SIMPLE to control industrial devices

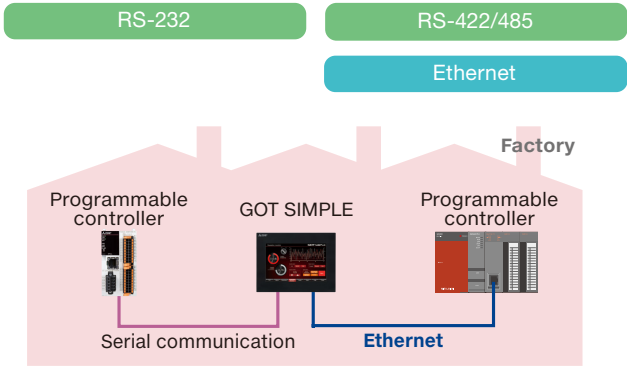

Multi-channel function

GOT supports various industrial devices and connection types. With the multi-channel function, two channels of industrial devices can be monitored on a single GOT.

Easily collect data from connected devices

Device data transfer function

Using GT Works3, simply set source devices, destination devices, and triggers and you can transfer data between industrial devices. Data on the connected devices can be collected in the programmable controller without a sequence program.

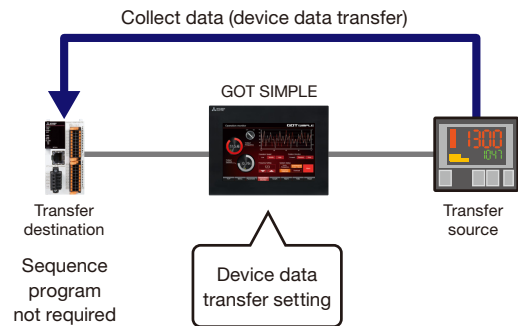

MODBUS® communication also supported

MODBUS® communication

As a master station, GOT can communicate with a MODBUS®/RTU slave device. Up to 31 devices (RS-485) can be connected for monitoring of production line, etc.

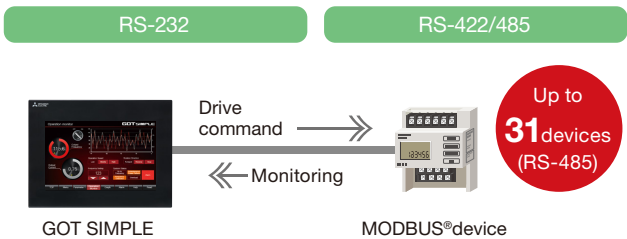

Simple, easy-to-understand setup

Recipe function & recipe display (record list)

GOT saves the recipe information (device values) such as material blend and machine conditions. You can change the recipe on the GOT and write it to a programmable controller to quickly perform the changeover. Changing recipes (changeover) is easy on a user-created screen or on the utility screen. The users can easily create screens by using the recipe display (record list).

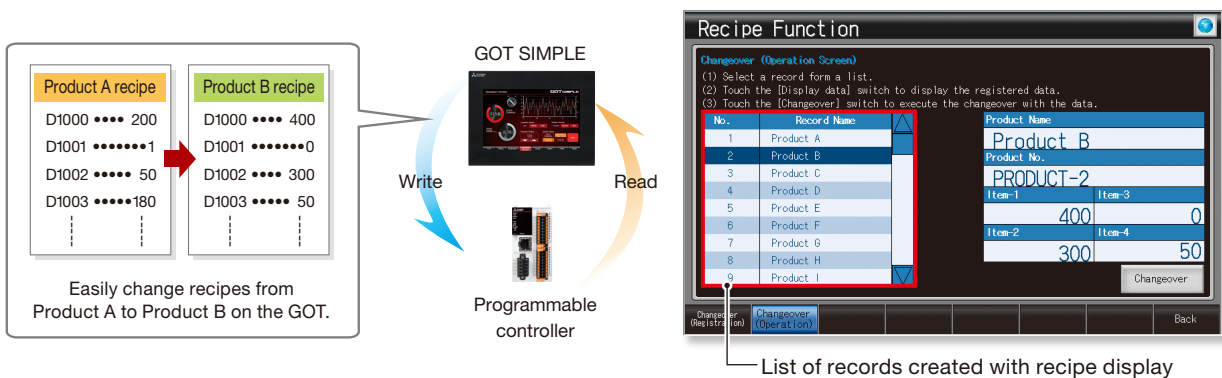

Display industrial devices alarms

Alarm function

Use the GOT to display and check alarms set by the users. Alarms of the connected device can be monitored and the equipment status can be checked. When a problem occurs, you can quickly troubleshoot the problem.

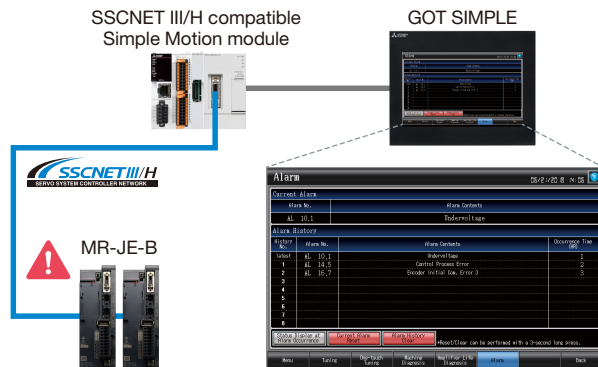

Increase efficiency of maintenance work

Reading/writing resource data

The GOT resource data can be read out to the PC, corrected, and then written back^{*1}. The efficiency of maintenance work is enhanced as there is no need to exchange data with an SD memory card.

^{*1} For the details on resource data that can be read and written, please refer to the GT Designer3 (GOT2000) Screen Design Manual.

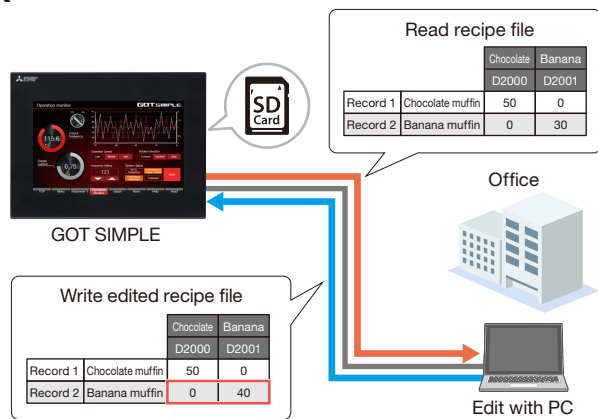

Reduce design, setup, and maintenance cost

Recommended

Monitor device value and set values for timer, etc.

Device monitor function

Monitor and change internal device ON/OFF status, word values, timer and counter values of connected devices such as MELSEC programmable controllers.

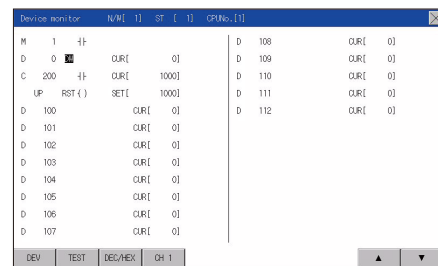

Program change without a personal computer on-site

MELSEC FX list editor

With the GOT, sequence programs of FX Series programmable controllers^{*1} can be edited in the list format. Convenient for minor on-site program changes.

^{*1} FX5CPU is not supported. For the details of connectable devices, please refer to the GOT2000 Series User's Manual (Monitor).

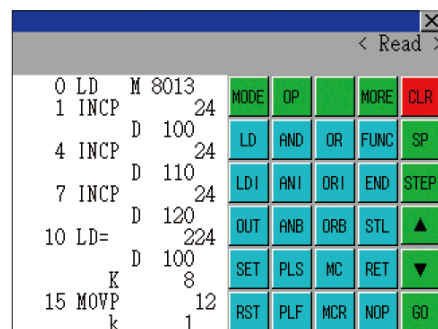

Add value to your installation and machine

Security with password management

Operator authentication function

Setting the operation authority and the viewing authority per operator achieves "enhanced security" and "prevention of improper operation". Operator authentication can be performed startup and when the screen is switched.

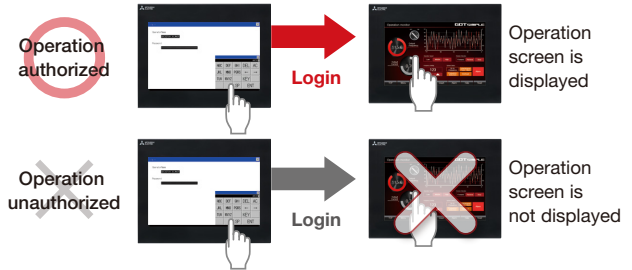

Operation log function

The operation information, such as the "what, when, and how" of an operation performed can be recorded in chronological order in an SD memory card and checked on a PC.

In addition, when combined with operator authentication function, it keeps track of "who" has operated the device and quickly identify the cause of the trouble.

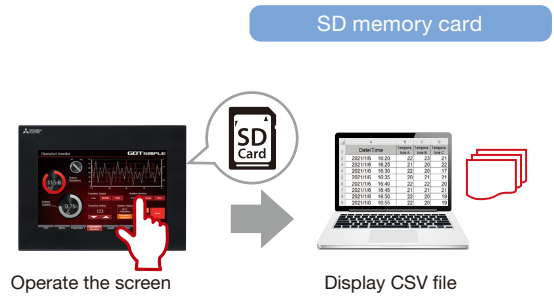

Easily exchange data with FTP

File transfer function

By using GOT, production results and alarm logs can be stored in an SD memory card of the GOT (FTP client) and sent to a PC (FTP server). The GOT can also receive the production instruction data from the PC.

By using the GOT as an FTP server, files can be read to and written from the PC that acts as an FTP client. (FTP server function)

Writing file from GOT to PC

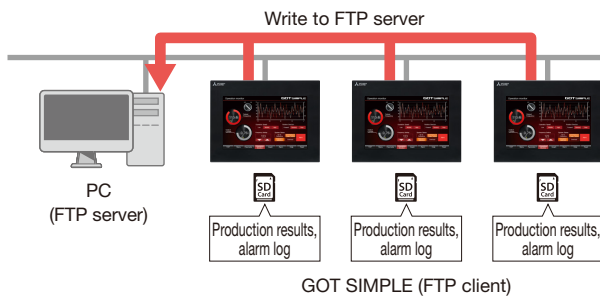

Reading file from PC to GOT

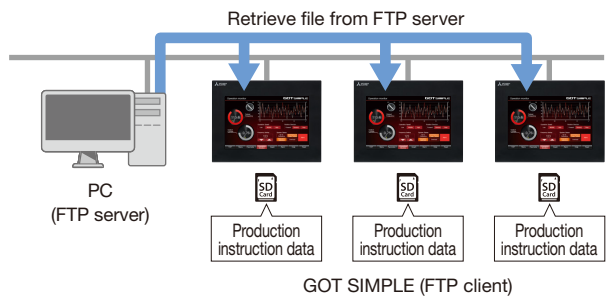

Reduce risk of unauthorized access through network

IP filter function

Registering the IP address of the device which can access the GOT restricts the access from unauthorized devices.

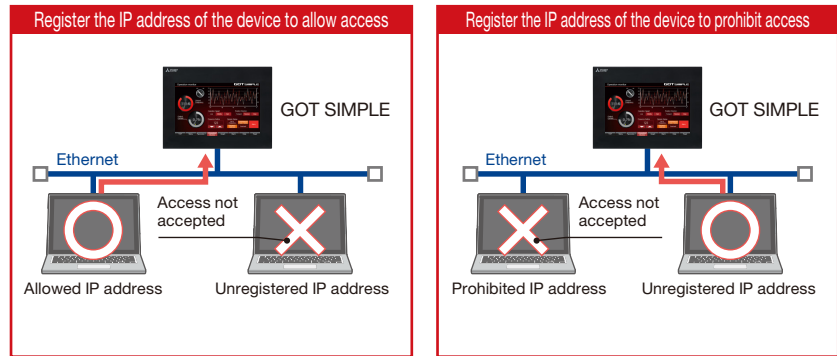

Multiple actions with a single switch

Multiple functions can be set to one switch, so there is no need for multiple switches for separate functions. By setting execution sequence and conditions, delay, repeat, interlock settings can be combined, reducing the burden of programmable controller programming.

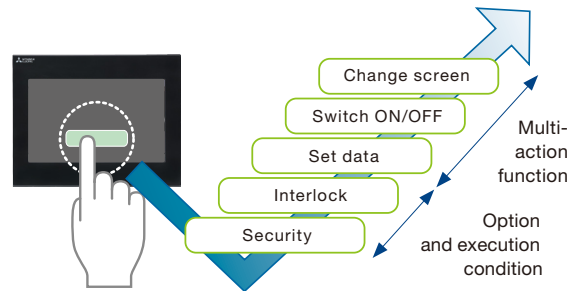

Easily installed on compact equipment

Vertical display

By using a GOT vertically, it can be easily installed on compact equipment and can neatly display vertical letters.

Less scrolling is needed when displaying lists.

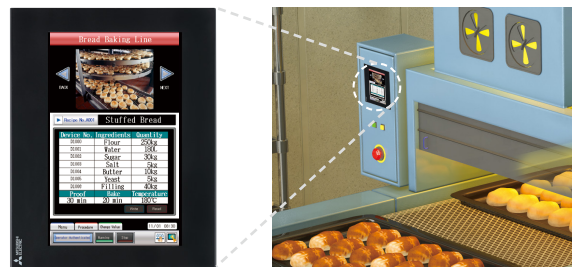

Streamlined screen design

GOT Screen Design Software
MELSOFT GT Works3

Pick and place intuitive screen design is easy even for beginners

Using parts is simple. Just select a part and place on the screen! Design your screen with intuitive pick and place operation.

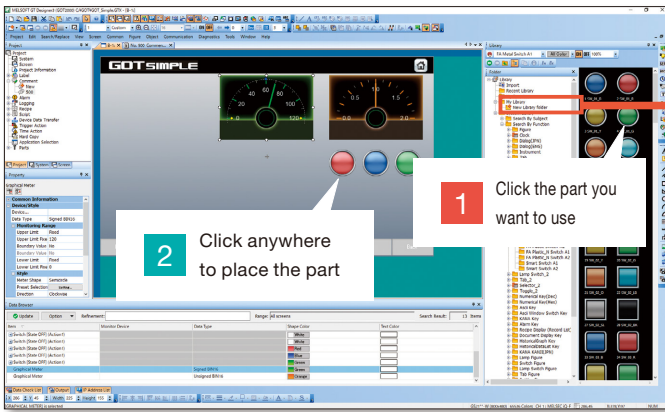

Reduce design time by registering frequently used parts to 'My Favorites' or 'My Library'. Import/export is also possible.

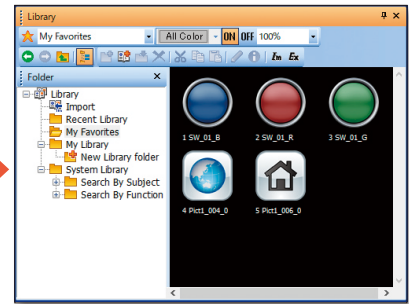

Utilize the past assets and sample screens

Individual screens can be utilized from past projects and sample projects. Select the screens to utilize, then drag and drop to launch the utilization wizard.

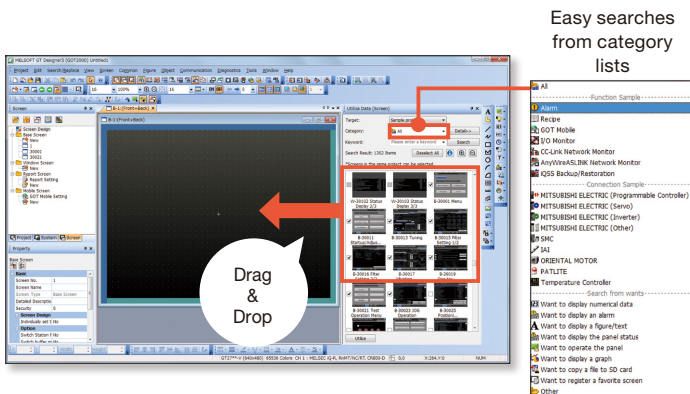

Utilization wizard

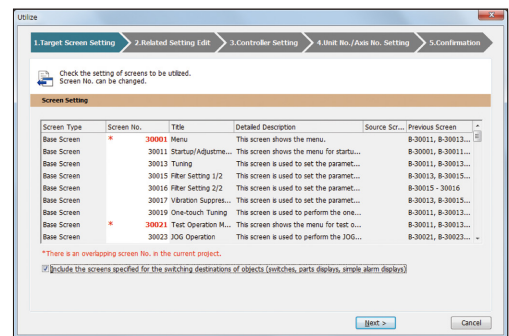

Simple step navigation. Settings related to target screen (comment group, logging, scripts, etc.) can also be utilized.

Easily create stylish meters with a graphical meter

Just select a meter from the preset list and you can create stylish, clear meters. The position and angle of scales can be adjusted by mouse operation and the shape and design can be changed easily. Warning color display indicates the machine status clearly.

Select from the toolbar

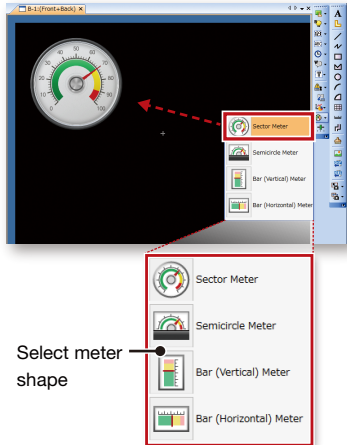

Select from the preset list



Easy to adjust settings by mouse operation

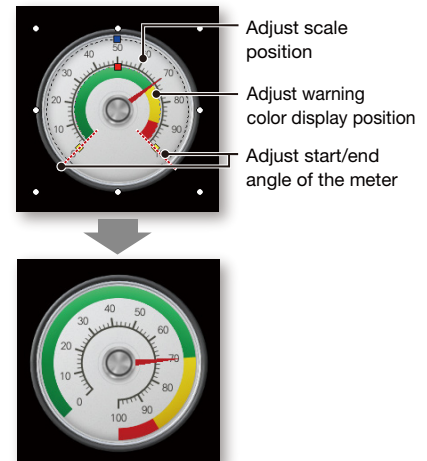

More beautiful graphics

With GOT Graphic Ver.2, you can select the required screen design and change it in a batch. Gradation drawing and transparency setting can be performed.

Screen design list

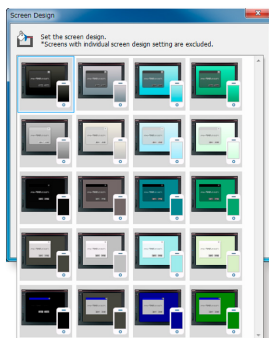

Gradation background and transparency setting of the window screen

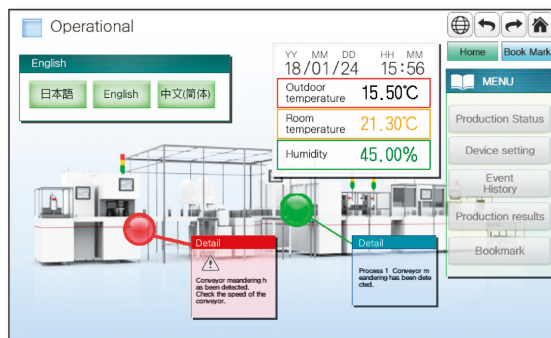

Function list

Category	Function name	Necessary devices ^{*1}	GT27	GT25	GT25 Wide	GT25 Handy	
Screen size	15"		●	—	—	—	
	12.1"		●	●	—	—	
	12.1" Wide		—	—	●	—	
	10.4"		—	●	—	—	
	10.1" Wide		—	—	●	—	
	10" Wide		—	—	—	—	
	8.4"		●	●	—	—	
	7" Wide		—	—	●	—	
	6.5"		—	—	—	●	
	5.7"		●	●	—	●	
	4.3"		—	—	—	—	
	3.8"		—	—	—	—	
	Hardware specifications	Resolution					
		WXGA 1280×800		—	—	●	—
		XGA 1024×768		●	—	—	—
		SVGA 800×600		●	●	—	—
		WVGA 800×480		—	—	●	—
		VGA 640×480		●	●	—	●
		Other		—	—	—	—
		Color					
		65536 colors		—	●	●	●
		Monochrome (black/white) 32 shade grayscale		—	—	—	—
Touch panel simultaneous press (2 points)		●	—	—	—		
Human sensor		● ^{*10}	—	—	—		
Memory	User memory for storage (ROM)		Other than below : 57MB GT2705 : 32MB	32MB	32MB	32MB	
	User memory for operation (RAM)		Other than below : 256MB ^{*2} GT2705 : 80MB	80MB	128MB	80MB	
Interface	RS-232		●	●	●	●	
	RS-422/485		●	●	●	● GT2505HS supports RS-422 only	
Interface	Ethernet	(Ethernet communication unit)	● 2 ports by installing communication unit	● 2 ports by installing communication unit ^{*7}	● 2 ports as standard	●	
	USB host		●	●	●	●	
	USB device		●	●	●	●	
	SD memory card interface		●	●	●	●	
	Extension interface	Communication units, option units	● ^{*11}	● ^{*11} ^{*7}	—	—	
	Figure/object functions						
Screen design	Figure		●	●	●	●	
	Logo text		●	●	●	●	
	Outline font		●	●	●	●	
	Touch switch		●	●	●	●	
	Lamp		●	●	●	●	
	Numerical display, Numerical input		●	●	●	●	
	Text display, Text input		●	●	●	●	
	Date display, Time display	(Battery)	●	●	●	●	
	Comment display		●	●	●	●	
	Parts display	(SD memory card or USB memory)	●	●	●	●	
	Parts movement	(SD memory card or USB memory)	●	●	●	●	
	Historical data list display	(SD memory card or USB memory)	●	●	●	●	
	Simple alarm display		●	●	●	●	
	System alarm display		●	●	●	●	
	Alarm display (user)	(SD memory card or USB memory, battery)	●	●	●	●	
	Alarm display (system)	(SD memory card or USB memory, battery)	●	●	●	●	
	Recipe display (record list)		●	●	●	●	
	Line graph		●	●	●	●	
	Trend graph		●	●	●	●	
	Bar graph		●	●	●	●	
	Statistic bar graph		●	●	●	●	
	Statistic pie graph		●	●	●	●	
	Scatter graph		●	●	●	●	
	Historical trend graph	(SD memory card or USB memory)	●	●	●	●	
	Graphical meter		●	●	●	●	
	Level		●	●	●	●	
	Panelmeter		●	●	●	●	
	Slider		●	●	●	●	
	Document display	SD memory card	●	●	●	●	
	Script parts		●	●	●	●	
Functions performed on background of GOT	Logging	(SD memory card or USB memory, battery)	●	●	●	●	
	Recipe	(SD memory card or USB memory, battery)	●	●	●	●	
	Device data transfer		●	●	●	●	
	Trigger action		●	●	●	●	
	Time action	(SD memory card or USB memory)	●	●	●	●	
	Hard copy	File output (BMP, JPEG)	(SD memory card or USB memory)	●	●	●	●
		File output (PDF)	(SD memory card or USB memory)	●	●	●	●
		Serial printer output		●	●	●	—
		Ethernet printer output		●	●	●	●
		PictBridge printer output	Printer unit	●	● ^{*17}	—	—
Project script, Screen script		●	●	●	●		
Object script		●	●	●	●		

*1 Necessary units when using GT27, GT25, GT25 wide, GT25 handy, GT25 rugged, GT21 wide, GT21 or GS21 models are shown. Parenthesized devices are required depending on conditions of use.

*2 Data is output to the printer that is recognized by the personal computer.

*3 CSV files are saved in the virtual drive of the personal computer so that it is recommended to output the files to printers.

*4 Only the GOTs with SVGA or higher resolution are supported.

*5 Remote personal computer operation function (Ethernet) cannot be used. The following screens are displayed horizontally: utility screen, monitor and data management screens that are displayed from the utility screen (sequence program

monitor, etc.), video camera images in the multimedia and video display functions. For the details of other GOT operations when placed vertically, please refer to the relevant product manual or Help.

*6 Excluding GT2103-PMBLS.

*7 GT2104-RTBD only.

*8 Excluding GT2705-VTBD.

*9 To use multiple units such as extension units, barcode readers, or RFID controllers with a GT2705-VTBD, the total current consumption of the units should be less than the value that the GT2705-VTBD can provide. For the details, please refer to the relevant manual of the GOT2000 Series.

For the details of functions, supported controllers, and connection types, please refer to the relevant manual or Help of the GOT2000/GOT SIMPLE Series.

●: Supported —: Not supported

Category	Function name	Necessary devices ^{*1}	GT25 Rugged	GT21 Wide	GT21	GS21-W-N	GT SoftGOT2000
Hardware specifications	Screen size						Flexible resolution 640 to 1920x480 to 1200
	15"		—	—	—	—	
	12.1"		—	—	—	—	
	12.1" Wide		—	—	—	—	
	10.4"		—	—	—	—	
	10.1" Wide		—	—	—	—	
	10" Wide		—	—	—	●	
	8.4"		—	—	—	—	
	7" Wide		●	●	—	●	
	6.5"		—	—	—	—	
	5.7"		—	—	—	—	
	4.3"		—	—	●	—	
	3.8"		—	—	●	—	
	Resolution	WXGA 1280x800		—	—	—	—
	XGA 1024x768		—	—	—	—	—
	SVGA 800x600		—	—	—	—	—
	WVGA 800x480		●	●	—	●	—
	VGA 640x480		—	—	—	—	—
	Other		—	—	GT2104-R:480x272 GT2103-P:320x128	—	—
	Color	65536 colors		●	●	●	●
	Monochrome (black/white) 32 shade grayscale		—	—	●	—	—
	Touch panel simultaneous press (2 points)		—	—	—	—	—
Human sensor		—	—	—	—	—	
Memory	User memory for storage (ROM)		32MB	15MB	GT2104-R:9MB GT2103-P:3MB	15MB	57MB
User memory for operation (RAM)		128MB	—	—	64MB ^{UP}	—	
Interface	RS-232		●	●	● ^{*20}	●	● ^{*12}
RS-422/485		●	●	●	●	●	● ^{*12}
Ethernet	(Ethernet communication unit)	2 ports as standard	●	●	● ^{*20}	●	● ^{*12}
USB host		●	●	—	—	—	● ^{*13}
USB device		●	●	●	●	—	—
SD memory card interface		●	●	● ^{*14}	●	—	● ^{*13}
Extension interface	Communication units, option units	—	—	—	—	—	● ^{*11}
Screen design	Figure		●	●	●	●	●
	Logo text		●	●	●	●	●
	Outline font		●	●	—	●	●
	Touch switch		●	●	●	●	●
	Lamp		●	●	●	●	●
	Numerical display, Numerical input		●	●	●	●	●
	Text display, Text input		●	●	●	●	●
	Date display, Time display	(Battery)	●	●	●	●	●
	Comment display		●	●	●	●	●
	Parts display	(SD memory card or USB memory)	●	●	● ^{*16}	●	●
	Parts movement	(SD memory card or USB memory)	●	●	● ^{*16}	●	●
	Historical data list display	(SD memory card or USB memory)	●	●	● ^{*16}	●	●
	Simple alarm display		●	●	●	●	●
	System alarm display		●	—	—	—	●
	Alarm display (user)	(SD memory card or USB memory, battery)	●	●	● ^{*16}	●	●
	Alarm display (system)	(SD memory card or USB memory, battery)	●	—	—	—	●
	Recipe display (record list)		●	●	●	●	●
	Line graph		●	●	●	●	●
	Trend graph		●	●	●	●	●
	Bar graph		●	●	●	●	●
	Statistic bar graph		●	●	●	●	●
	Statistic pie graph		●	●	●	●	●
	Scatter graph		●	●	●	●	●
	Historical trend graph	(SD memory card or USB memory)	●	●	● ^{*16}	●	●
	Graphical meter		●	●	●	●	●
	Level		●	●	●	●	●
	Panelmeter		●	●	●	●	●
	Slider		●	●	●	●	●
	Document display	SD memory card	●	—	—	—	●
	Script parts		●	●	●	●	●
	Logging	(SD memory card or USB memory, battery)	●	●	● ^{*16}	●	●
	Recipe	(SD memory card or USB memory, battery)	●	●	● ^{*16}	●	●
	Device data transfer		●	●	●	●	●
Trigger action		●	●	●	●	●	
Time action	(SD memory card or USB memory)	●	●	●	●	●	
Hard copy	File output (BMP, JPEG)	(SD memory card or USB memory)	●	●	● ^{*16}	●	●
	File output (PDF)	(SD memory card or USB memory)	●	—	—	—	—
	Serial printer output		●	●	● ^{*16}	●	● ^{*2}
	Ethernet printer output		●	●	● ^{*15}	●	● ^{*2}
	PictBridge printer output	Printer unit	—	—	—	—	● ^{*2}
Project script, Screen script		●	●	●	●	●	
Object script		●	—	—	—	●	

^{*10} GT2715-XTBA, GT2715-XTBD, GT2712-STBA, GT2712-STBD, GT2712-STWA, GT2712-STWD only.
^{*11} For the applicable communication units, option units and interface boards, please refer to the relevant product manual.
^{*12} Use the standard interface of the personal computer.
^{*13} When using functions that require a USB memory or SD memory card, a virtual drive in the personal computer is used.
^{*14} GT2103-PMBD, GT2103-PMBDS, and GT2103-PMBDS2 require an SD memory card unit (GT21-03SDCCD) separately. GT2103-PMBLS does not allow for SD memory cards.
^{*15} GT2104-RTBD, GT2103-PMBD only.
^{*16} On GT2103-PMBLS, only the functions that do not require SD memory card can be used.

^{*17} Excluding GT2505-VTBD.
^{*18} GT25 wide and GT25 rugged models have a built-in sound output interface so that the sound output unit is not required.
^{*19} GT2505HS-VTBD supports the function with Ethernet connection only.
^{*20} GT21 has different interfaces depending on the model. For the details, please refer to the relevant product manual.
^{*21} Only Ethernet, OPC UA client, and microcomputer connections are supported.
^{*22} If the function version is B or earlier, the memory for operation (RAM) is 128 MB.
^{*23} GT SoftGOT2000 supports the server function only.
^{*24} It is recommended to use GT SoftGOT2000 (Multiple channel) for this function.
^{*25} Compatible with only GT SoftGOT2000 (Multiple channel).

Function list

Category	Function name	Necessary devices ^{*1}	GT27	GT25	GT25 Wide	GT25 Handy	
Screen design	Barcode function		●	●	●	—	
	RFID function		●	●	●	—	
	GOT Mobile function	License, (SD memory card)	●	●	●	●	
	VNC server function	License	●	●	●	●	
	Remote personal computer operation function (Ethernet)	License	●	●	●	●	
	Remote personal computer operation function (serial)	RGB input unit or Video/RGB input unit	● ⁹	—	—	—	
	Video display function	Video input unit or Video/RGB input unit	● ⁹	—	—	—	
	RGB display function	RGB input unit or Video/RGB input unit	● ⁹	—	—	—	
	Multimedia function	Multimedia unit, CF card	● ⁹	—	—	—	
	External I/O function	External I/O unit	●	● ¹⁷	—	—	
	Operation panel function	External I/O unit	●	● ¹⁷	—	—	
	Video output function	HDMI output	Digital video output unit	● ⁹	—	—	—
		RGB output	RGB output unit	● ⁹	—	—	—
		File output	(SD memory card or USB memory)	●	●	●	●
	Report function	Serial printer output	(SD memory card or USB memory)	●	●	●	—
		Ethernet printer output	(SD memory card or USB memory)	●	●	●	●
		PictBridge printer output	SD memory card or USB memory, printer unit	●	● ¹⁷	—	—
		Sound output function	Sound output unit ¹⁸	●	● ¹⁷	● ¹⁸	—
	Server function, Client function		●	●	●	●	
	Mail send function		●	●	●	●	
	Network drive function		●	●	●	●	
	FTP server function	(SD memory card or USB memory)	●	●	●	●	
	File transfer function (FTP transfer)	SD memory card or USB memory	●	●	●	●	
	File transfer function (GOT internal transfer)	SD memory card or USB memory	●	●	●	●	
	MES interface function	License, (SD memory card)	●	●	●	●	
	USB mouse, USB keyboard		●	●	●	—	
	GOT functions	Base screen		●	●	●	●
		Overlap window		●	●	●	●
		Superimpose window		●	●	●	●
		Dialog window		●	●	●	●
		Mobile screen		●	●	●	●
		Key window		●	●	●	●
		Language switching		●	●	●	●
System information			●	●	●	●	
Operator authentication function		(SD memory card or USB memory)	●	●	●	●	
Operation log		SD memory card or USB memory	●	●	●	●	
Startup logo			●	●	●	●	
KANA KANJI/Pinyin conversion			●	●	●	●	
FA transparent			●	●	●	●	
SoftGOT-GOT link		License key	●	●	●	●	
Backup/Restoration		SD memory card or USB memory	●	●	●	●	
Multi-channel function			● ⁹ 4 channels (Up to 3 units)	● ⁹ 4 channels (Up to 3 units ¹⁷)	● ⁹ 4 channels (No units can be mounted)	● ¹⁹ 4 channels (No units can be mounted)	
Station No. switching			●	●	●	●	
GOT network interaction			●	●	●	●	
Screen gesture function			●	—	—	—	
Object gesture function			●	—	—	—	
Security key authentication function			●	●	●	●	
IP filter function			●	●	●	●	
File manager		(SD memory card or USB memory)	●	●	●	●	
Vertical display ⁵			● (Rotate 90° to left)	● (Other than below: rotate 90° to left GT2505; rotate 90° to right)	● (Rotate 90° to left)	—	
Vision sensor monitor			●	●	●	●	
Maintenance functions		Device monitor	(SD memory card or USB memory)	●	●	●	●
		Sequence program monitor (iQ-R ladder)	SD memory card or USB memory	●	●	●	●
	Sequence program monitor (iQ-F ladder)	SD memory card or USB memory	●	●	●	●	
	Sequence program monitor (Ladder)	SD memory card or USB memory	●	●	●	●	
	Sequence program monitor (SFC)	SD memory card or USB memory	●	●	●	●	
	Network monitor		●	●	●	●	
	CC-Link IE TSN / CC-Link IE Field Network diagnostics		●	●	●	●	
	Intelligent module monitor		●	●	●	●	
	Drive recorder	(SD memory card or USB memory)	●	●	●	●	
	Servo amplifier graph	(SD memory card or USB memory)	●	●	●	●	
	Motion program editor		● ⁴	● ⁴	● ⁴	—	
	Motion program I/O	SD memory card or USB memory	● ⁴	● ⁴	● ⁴	—	
	Servo amplifier monitor		●	●	●	●	
	R motion monitor		●	●	●	●	
	Q motion monitor		●	●	●	●	
	R Motion SFC monitor	SD memory card or USB memory	●	●	●	●	
	Q Motion SFC monitor	SD memory card or USB memory	●	●	●	●	
	CNC monitor 2		●	●	—	●	
	CNC monitor		● ⁴	● ⁴	—	—	
	CNC data I/O	SD memory card or USB memory	● ⁴	● ⁴	—	—	
	CNC machining program edit		● ⁴	● ⁴	—	—	
	Log viewer	(SD memory card or USB memory)	●	●	●	●	
	FX list editor		●	●	—	●	
	FX ladder monitor		●	●	●	●	
	iQSS utility	SD memory card or USB memory	●	●	●	●	
	System launcher		●	●	●	●	
	System launcher (servo network)		●	●	●	●	
MELSEC-L troubleshooting		●	●	●	●		
GOT off line monitor	(SD memory card or USB memory, battery)	●	●	●	●		

^{*1} Necessary units when using GT27, GT25, GT25 wide, GT25 handy, GT25 rugged, GT21 wide, GT21 or GS21 models are shown. Parenthesized devices are required depending on conditions of use.
^{*2} Data is output to the printer that is recognized by the personal computer.
^{*3} CSV files are saved in the virtual drive of the personal computer so that it is recommended to output the files to printers.
^{*4} Only the GOTs with SVGA or higher resolution are supported.
^{*5} Remote personal computer operation function (Ethernet) cannot be used. The following screens are displayed horizontally: utility screen, monitor and data management screens that are displayed from the utility screen (sequence program

monitor, etc.), video camera images in the multimedia and video display functions. For the details of other GOT operations when placed vertically, please refer to the relevant product manual or Help.
^{*6} Excluding GT2103-PMBLS.
^{*7} GT2104-RTBD only.
^{*8} Excluding GT2705-VTBD.
^{*9} To use multiple units such as extension units, barcode readers, or RFID controllers with a GT2705-VTBD, the total current consumption of the units should be less than the value that the GT2705-VTBD can provide. For the details, please refer to the relevant manual of the GOT2000 Series.

For the details of functions, supported controllers, and connection types, please refer to the relevant manual or Help of the GOT2000/GOT SIMPLE Series.

●: Supported —:Not supported

Category	Function name	Necessary devices ^{*1}	GT25 Rugged	GT21 Wide	GT21	GS21-W-N	GT SoftGOT2000	
Screen design	Barcode function		●	●	● ^{*6}	●	●	
	RFID function		●	●	● ^{*6}	●	●	
	GOT Mobile function	License, (SD memory card)	●	—	—	—	● ^{*24}	
	VNC server function	License	●	●	—	●	—	
	Remote personal computer operation function (Ethernet)	License	●	—	—	—	—	
	Remote personal computer operation function (serial)	RGB input unit or Video/RGB input unit	—	—	—	—	—	
	Video display function	Video input unit or Video/RGB input unit	—	—	—	—	—	
	RGB display function	RGB input unit or Video/RGB input unit	—	—	—	—	—	
	Multimedia function	Multimedia unit, CF card	—	—	—	—	—	
	External I/O function	External I/O unit	—	—	—	—	—	
	Operation panel function	External I/O unit	—	—	—	—	●	
	Video output function	HDMI output	Digital video output unit	—	—	—	—	—
		RGB output	RGB output unit	—	—	—	—	—
	Report function	File output	(SD memory card or USB memory)	●	—	—	—	● ^{*3}
		Serial printer output	(SD memory card or USB memory)	●	●	● ^{*6}	●	● ^{*3}
		Ethernet printer output	(SD memory card or USB memory)	●	●	● ^{*15}	●	● ^{*3}
		PictBridge printer output	SD memory card or USB memory, printer unit	—	—	—	—	● ^{*3}
	Sound output function	Sound output unit ^{*18}	● ^{*18}	—	—	—	●	
	Server function, Client function		●	—	—	—	● ^{*23}	
	Mail send function		●	—	—	—	●	
	Network drive function		●	—	—	—	●	
	FTP server function	(SD memory card or USB memory)	●	●	● ^{*15}	●	—	
	File transfer function (FTP transfer)	SD memory card or USB memory	●	●	● ^{*15}	●	—	
	File transfer function (GOT internal transfer)	SD memory card or USB memory	●	—	—	—	—	
MES interface function	License, (SD memory card)	●	—	—	—	—		
USB mouse, USB keyboard		●	●	—	—	●		
GOT functions	Base screen		●	●	●	●	●	
	Overlap window		●	●	●	●	●	
	Superimpose window		●	●	●	●	●	
	Dialog window		●	●	●	●	●	
	Mobile screen		●	—	—	—	● ^{*24}	
	Key window		●	●	●	●	●	
	Language switching		●	●	●	●	●	
	System information		●	●	●	●	●	
	Operator authentication function	(SD memory card or USB memory)	●	●	● ^{*16}	●	●	
	Operation log	SD memory card or USB memory	●	●	—	●	●	
	Startup logo		●	●	●	●	●	
	KANA KANJI/Pinyin conversion		●	●	●	●	●	
	FA transparent		●	●	●	●	—	
	SoftGOT-GOT link	License key	●	—	—	—	●	
	Backup/Restoration	SD memory card or USB memory	●	●	● ^{*6}	●	● ^{*25}	
	Multi-channel function		4 channels (No units can be mounted)	2 channels (No units can be mounted)	2 channels (No units can be mounted)	2 channels (No units can be mounted)	4 channels ● ^{*21}	
	Station No. switching		●	●	●	●	●	
	GOT network interaction		●	—	—	—	●	
	Screen gesture function		—	—	—	—	—	
	Object gesture function		—	—	—	—	—	
	Security key authentication function		●	●	●	●	—	
	IP filter function		●	●	●	●	—	
	File manager	(SD memory card or USB memory)	●	—	—	—	—	
	Vertical display ^{*5}		(Rotate 90° to left)	(Rotate 90° to left)	(Rotate 90° to right)	(Rotate 90° to left)	—	
Vision sensor monitor		●	—	—	—	—		
Maintenance functions	Device monitor	(SD memory card or USB memory)	●	●	●	●	—	
	Sequence program monitor (iQ-R ladder)	SD memory card or USB memory	●	—	—	—	—	
	Sequence program monitor (iQ-F ladder)	SD memory card or USB memory	●	—	—	—	—	
	Sequence program monitor (Ladder)	SD memory card or USB memory	●	—	—	—	—	
	Sequence program monitor (SFC)	SD memory card or USB memory	●	—	—	—	—	
	Network monitor		●	—	—	—	—	
	CC-Link IE TSN / CC-Link IE Field Network diagnostics		●	—	—	—	—	
	Intelligent module monitor		●	—	—	—	—	
	Drive recorder	(SD memory card or USB memory)	●	—	—	—	● ^{*25}	
	Servo amplifier graph	(SD memory card or USB memory)	●	—	—	—	● ^{*25}	
	Motion program editor		—	—	—	—	—	
	Motion program I/O	SD memory card or USB memory	—	—	—	—	—	
	Servo amplifier monitor		●	—	—	—	—	
	R motion monitor		●	—	—	—	—	
	Q motion monitor		●	—	—	—	—	
	R Motion SFC monitor	SD memory card or USB memory	●	—	—	—	—	
	Q Motion SFC monitor	SD memory card or USB memory	●	—	—	—	—	
	CNC monitor 2		—	—	—	—	—	
	CNC monitor		—	—	—	—	—	
	CNC data I/O	SD memory card or USB memory	—	—	—	—	—	
	CNC machining program edit		—	—	—	—	—	
	Log viewer	(SD memory card or USB memory)	●	—	—	—	—	
	FX list editor		—	●	● ^{*7}	●	—	
	FX ladder monitor		●	—	—	—	—	
iQSS utility	SD memory card or USB memory	●	—	—	—	—		
System launcher		●	—	—	—	● ^{*25}		
System launcher (servo network)		●	—	—	—	● ^{*25}		
MELSEC-L troubleshooting		●	—	—	—	—		
GOT off line monitor	(SD memory card or USB memory, battery)	●	—	—	—	●		

^{*10} GT2715-XTBA, GT2715-XTBD, GT2712-STBA, GT2712-STBD, GT2712-STWA, GT2712-STWD only.
^{*11} For the applicable communication units, option units and interface boards, please refer to the relevant product manual.
^{*12} Use the standard interface of the personal computer.
^{*13} When using functions that require a USB memory or SD memory card, a virtual drive in the personal computer is used.
^{*14} GT2103-PMBD, GT2103-PMBDS, and GT2103-PMBDS2 require an SD memory card unit (GT21-03SDCD) separately. GT2103-PMBLS does not allow for SD memory cards.
^{*15} GT2104-RTBD, GT2103-PMBD only.
^{*16} On GT2103-PMBLS, only the functions that do not require SD memory card can be used.

^{*17} Excluding GT2505-VTBD.
^{*18} GT25 wide and GT25 rugged models have a built-in sound output interface so that the sound output unit is not required.
^{*19} GT2505HS-VTBD supports the function with Ethernet connection only.
^{*20} GT21 has different interfaces depending on the model. For the details, please refer to the relevant product manual.
^{*21} Only Ethernet, OPC UA client, and microcomputer connections are supported.
^{*22} If the function version is B or earlier, the memory for operation (RAM) is 128 MB.
^{*23} GT SoftGOT2000 supports the server function only.
^{*24} It is recommended to use GT SoftGOT2000 (Multiple channel) for this function.
^{*25} Compatible with only GT SoftGOT2000 (Multiple channel).

Specifications

General specifications

Item	Specifications					
Operating ambient temperature ^{*1}	0°C to 50°C					
Storage ambient temperature	-20°C to 60°C					
Operating/Storage ambient humidity	10% RH to 90% RH, non-condensing ^{*2}					
Vibration resistance	Compliant with IEC 61131-2 ^{*3}	Under intermittent vibration	Frequency	Acceleration	Half amplitude	Sweep count
			5 to 8.4 Hz	—	3.5 mm	10 times in each X, Y, or Z direction
		Under continuous vibration	5 to 8.4 Hz	—	1.75 mm	—
			8.4 to 150 Hz	4.9 m/s ²	—	
Shock resistance	Compliant with IEC 61131-2 ^{*4} (147 m/s ² (15G), 3 times in each X, Y, or Z direction)					
Operating atmosphere	No greasy fumes, corrosive gas, flammable gas, excessive conductive dust, and direct sunlight (as well as at storage)					
Operating altitude ^{*5}	2000 m or less					
Installation location	Inside control panel					
Overvoltage category ^{*6}	II or less					
Pollution degree ^{*5}	2 or less					
Cooling method	Self-cooling					
Grounding	Grounding with a ground resistance of 100 Ω or less by using a ground cable that has a cross-sectional area of 2 mm ² or more. If impossible, connect the ground cable to the control panel.					

Operate and store the GOT in environments without direct sunlight, high temperature, dust, humidity, and vibrations.

For the status of conforming to various standards and laws (CE, UKCA, ATEX, UL/cUL, KC, KCs), please contact your local sales office.

Power supply specifications

Item	Specifications		
	GS2110-WTBD-N	GS2107-WTBD-N	
Power supply voltage	24 V DC (+10%, -15%), ripple voltage 200 mV or less		
Power consumption	Under the maximum load	7.6 W (317 mA/24 V) or less	6.5 W (271 mA/24 V) or less
	Backlight OFF	3.8 W (158 mA/24 V) or less	3.8 W (158 mA/24 V) or less
Inrush current	17 A or less (6 ms, ambient temperature 25°C, at the maximum load)		
Permissible instantaneous power failure time	Within 5 ms		
Noise immunity	Conforms to IEC61000-4-2, 4 kV (power supply line)		
Withstand voltage	350 V AC for 1 minute across power terminals and earth		
Insulation resistance	500 V DC across power terminals and earth, 10 MΩ or more by an insulation resistance tester		

^{*1} Includes the temperature inside the enclosure of the control panel to which the GOT is installed.

^{*2} If the ambient temperature exceeds 40°C, the absolute humidity must not exceed 90% RH at 40°C.

^{*3} Do not use or store the GOT under a pressure higher than the atmospheric pressure at altitude 0 m. Doing so may cause a malfunction. Air purging by applying pressure to the control panel may create clearance between the surface sheet and the touch panel. This may cause the touch panel to be not sensitive enough or the sheet to come off.

^{*4} This indicates the section of the power supply to which the equipment is assumed to be connected between the public electrical power distribution network and the machinery within the premises. Category II applies to equipment that is supplied with power from fixed facilities. The withstand surge voltage for the equipment with the rated voltage up to 300 V is 2500 V.

^{*5} This indicates the occurrence rate of conductive material in an environment where a device is used. Pollution degree 2 indicates an environment where only non-conductive pollution occurs normally and a temporary conductivity caused by condensation shall be expected depending on the conditions.

^{*6} The definition of 1 G has been changed from 9.8 m/s² to 10 m/s² in IEC 61131-2 ED.3. The product was tested by using the former definition, 1 G = 9.8 m/s².

Performance specifications

Item	Specifications		
	GS2110-WTBD-N	GS2107-WTBD-N	
Display section ^{*1,*2}	Display device	TFT color LCD	
	Screen size	10" widescreen	
	Resolution	WVGA: 800 × 480 dots	
	Display size	222(8.74) (W) × 132.5(5.22) (H) mm(inch)	154(6.06) (W) × 85.9(3.38) (H) mm(inch)
	Number of displayed characters	16-dot standard font: 50 characters × 30 lines (two-byte characters) 12-dot standard font: 66 characters × 40 lines (two-byte characters)	
	Display color	65536 colors	
	Brightness adjustment	32 levels	
	Backlight ^{*4}	LED (not replaceable)	
Touch panel ^{*3,*9}	Type	Analog resistive film	
	Key size	Minimum 2 × 2 dots ^{*7} (per key)	
	Simultaneous press	Not available ^{*5} (Only 1 point can be touched.)	
	Life	1 million touches or more (operating force: 0.98 N or less)	
Panel color	Black		
Memory	Memory capacity	Memory for storage (ROM) ^{*8} : 32 MB (User memory: 15 MB) Memory for operation (RAM): 128 MB (User memory: 64 MB ^{*11})	
	Life (number of write times)	100000 times	
Built-in interface	RS-422/485	1 channel Transmission speed: 115200, 57600, 38400, 19200, 9600, 4800 bps Connector shape: D-sub 9-pin (female) Terminating resistor: 330 Ω, 110 Ω, OPEN (Selectable by the terminating resistor setting switch.)	
	RS-232	1 channel Transmission speed: 115200, 57600, 38400, 19200, 9600, 4800 bps Connector shape: D-sub 9-pin (male)	
	Ethernet	1 channel Data transfer method: 100BASE-TX, 10BASE-T Connector shape: RJ45 (modular jack) AUTO MDI/MDI-X	
	USB (device)	1 channel (rear face) USB version: USB 1.1 (Full-Speed 12 Mbps) Connector shape: USB Mini-B	
	SD memory card ^{*10}	1 channel, SDHC compliant (maximum 32 GB)	
Buzzer output	Single tone (tone length adjustable)		
Protective structure ^{*6}	Front: IP65F ^{*8}		
Safety standards, radio laws (as of August 2024)	CE, UKCA, UL, cUL, KC		
External dimensions	272(10.71) (W) × 214(8.43) (H) × 56(2.20) (D) mm(inch)	206(8.11) (W) × 155(6.10) (H) × 50(1.97) (D) mm(inch)	
Panel cut dimensions	258(10.16) (W) × 200(7.87) (H) mm(inch)	191(7.52) (W) × 137(5.39) (H) mm(inch)	
Weight (excluding a fitting)	1.3(2.9) kg(lb)	0.9(2.0) kg(lb)	
Compatible software package	GT Works3 Version 1.320J or later		

^{*1} As a characteristic of liquid crystal display panels, bright dots (always lit) and dark dots (never lit) may appear on the panel. Since liquid crystal display panels comprise a great number of display elements, the appearance of bright and dark dots cannot be reduced to zero. Individual differences in liquid crystal display panels may cause differences in color, uneven brightness and flickering. Note that these phenomena are characteristics of liquid crystal display panels and it does not mean the products are defective or damaged.

^{*2} Flickering may occur due to vibration, shock, or the display colors.

^{*3} When a stylus is used, the touch panel has a life of 100 thousand touches. The stylus must satisfy the following specifications.

- Material: polyacetal resin
- Tip radius: 0.8 mm or more

^{*4} To prevent the display section from burning in and lengthen the backlight life, enable the screen save function and turn off the backlight.

^{*5} If you touch two points or more simultaneously on the touch panel, a switch in an unintended location may operate. Do not touch two points or more simultaneously on the touch panel.

^{*6} Note that the structure does not guarantee protection in all users' environments. The GOT may not be used in certain environments where it is subjected to splashing oil or chemicals for a long period of time or soaked in oil mist.

^{*7} The minimum size of a key that can be arranged. To ensure safe use of the product, the following settings are recommended.

- Key size: 16 × 16 dots or larger
- Distance between keys: 16 dots or more

^{*8} The suffix "F" of IP65F is a symbol that indicates protection rate against oil. It is described in the Appendix of Japanese Industrial Standard JIS C 0920.

^{*9} Repeatedly touching the outer edge of the actual display area may cause the product to fail.

^{*10} While writing data to the memory for storage (ROM) or an SD memory card, if GOT is powered off, the data may be corrupted which may cause the GOT to stop operating.

^{*11} Up to 64 MB of memory for operation (RAM) can be used by writing BootOS with a version of the basic system application of 01.55.*** or later. Also, please design the GOT screen using GT Works3 Version 1.320J.

Panel cutting dimensions

Screen size	Model	A	B	C*
10" widescreen	GS2110-WTBD-N	258 (10.16) ^{+2(0.08)} ₀₍₀₎	200 (7.87) ^{+2(0.08)} ₀₍₀₎	10 (0.39) or more
7" widescreen	GS2107-WTBD-N	191 (7.52) ^{+2(0.08)} ₀₍₀₎	137 (5.39) ^{+2(0.08)} ₀₍₀₎	10 (0.39) or more

Unit: mm (inch)

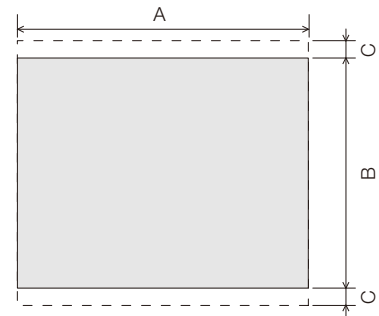

Panel thickness 1.6 to 4mm
(0.06 to 0.16 inch)

* Dimension C is required for installing fittings on the control panel.

External dimensions

■ GS2110-WTBD-N

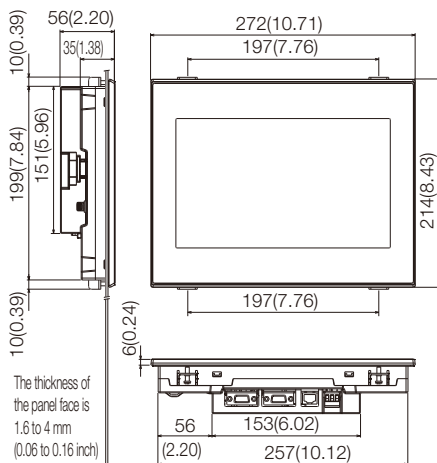

■ GS2107-WTBD-N

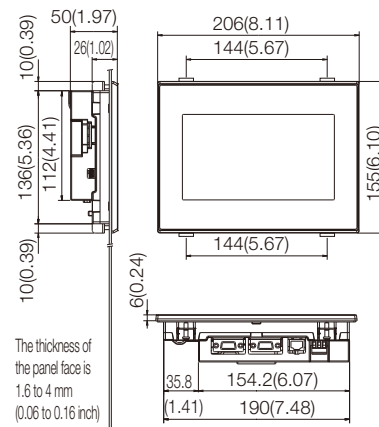

Unit: mm (inch)

Part names

■ GS2110-WTBD-N

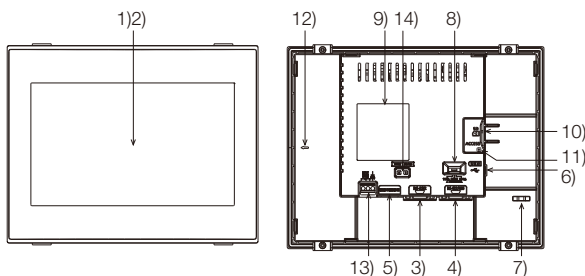

■ GS2107-WTBD-N

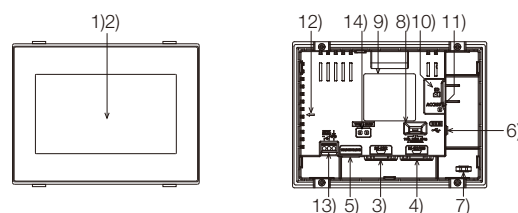

- 1) Display section
- 2) Touch panel
- 3) RS-232 interface
- 4) RS-422/485 interface
- 5) Ethernet interface
- 6) USB interface (Device)
- 7) Hole for preventing the USB cable from unplugging
- 8) Terminating resistor setting switch
- 9) Rating plate
- 10) SD memory card interface
- 11) SD memory card access LED
- 12) Vertical installation arrow mark
- 13) Power terminal
- 14) Ethernet communication status LED
- 15) Hole for unit installation fittings

Product list

GOTs

Product name	Model	Screen size	Display section/Display color	Panel color	Power
GOT SIMPLE Series	GS2110-WTBD-N	10" WVGA	TFT color/65536 colors	Black	24 V DC
	GS2107-WTBD-N	7" WVGA			

Communication unit

Product name	Model	Specifications
Serial multi-drop connection unit	GT01-RS4-M	For GOT multi-drop connection

Software

Product name	Model	Description		
HMI/GOT Screen Design Software MELSOFT GT Works3	SW1DND-GTWK3-EC	English Version	Site license product ^{*1}	DVD
FA Integrated Engineering Software MELSOFT iQ Works ^{*2}	SW2DND-IQWK-EC	English Version	Site license product ^{*1}	DVD
VNC Server Function License ^{*3}	GT25-VNCSKEY-1	1 license product ^{*4}		
License key for GT SoftGOT2000 ^{*4}	GT27-SGTKEY-U	USB port license key		

*1 Anyone can use the product as long as that person belongs to the business office (including overseas offices) of the corporation that purchased the product, or to the same public vocational training facility or other educational institution as the corporation.

*2 The product includes the following software.

- System Management Software [MELSOFT Navigator]
- Programmable Controller Engineering Software [MELSOFT GX Works3, GX Works2, GX Developer]
- Motion Controller Engineering Software [MELSOFT MT Works2]
- HMI/GOT Screen Design Software [MELSOFT GT Works3]
- Robot Engineering Software [MELSOFT RT ToolBox3¹]
- Inverter Setup Software [MELSOFT FR Configurator2]
- Setting/monitoring tools for the C Controller module and MELSECWinCPU [MELSOFT CW Configurator]
- Servo Setup Software [MELSOFT MR Configurator2]
- MITSUBISHI ELECTRIC FA Library

*RT ToolBox3 mini (simplified version) will be installed if iQ Works product ID is used. When RT ToolBox3 (with simulation function) is required, please purchase RT ToolBox3.

*3 One license is required for one GOT.

*4 To use GT SoftGOT2000, each personal computer requires a license key for GT SoftGOT2000.

*5 Products with 5, 10, or 20 licenses are also available. For details, please contact your local sales office.

Options

Product name	Model	Specifications
SD memory card	NZ1MEM-2GBSD	SD memory card for GOT, 2 GB
	NZ1MEM-4GBSD	SDHC memory card for GOT, 4 GB
	NZ1MEM-8GBSD	SDHC memory card for GOT, 8 GB
	NZ1MEM-16GBSD	SDHC memory card for GOT, 16 GB

Application packages

Product name	Model	Description
iQ Monozukuri Process Remote Monitoring ^{*1}	AP30-PRM001AA-MA	1 license
	AP30-PRM001AA-MB	5 licenses
	AP30-PRM001AA-MC	10 licenses

*1 Process Remote Monitoring setting tool, iQ Monozukuri Process Remote Monitoring template project for GT SoftGOT2000, and the Process Remote Monitoring license are included.

Mobile application

Product name	Description
Pocket GOT	<p>Available on App Store NEW or Google Play™.</p> <p>* The app can be used on iPhone, iPad NEW, or Android™ devices.</p> <p>For information about the operating environment, please check App Store or Google Play™.</p> <p>• Up to 20 GOTs can be registered on a single mobile terminal with the mobile app Pocket GOT installed.</p>

Cables

Product name	Model	Cable length	Recommended product *1	Specifications	
RS-422 connector conversion Cable	FA-CNV2402CBL	0.2 m	○	QCPU/L02SCPU(-P) ⇔ RS-422 cable (GT01-C□R4-25P, GT10-C□R4-25P, GT21-C□R4-25P5) L6ADPR2 ⇔ RS-422 cable (GT01-C□R4-25P, GT10-C□R4-25P, GT21-C□R4-25P5) [MINI-DIN 6-pin ⇔ D-sub 25-pin]	
	FA-CNV2405CBL	0.5 m			
RS-422 cable	FXCPU direct connection cable, FXCPU communication expansion board connection cable	GT01-C10R4-8P	1 m	-	FXCPU ⇔ GOT FXCPU communication expansion board ⇔ GOT [MINI-DIN 8-pin ⇔ D-sub 9-pin]
		GT01-C30R4-8P	3 m		
		GT01-C100R4-8P	10 m		
		GT01-C200R4-8P	20 m		
		GT01-C300R4-8P	30 m		
	QnA/A/FXCPU direct connection cable, Computer link connection cable, CC-Link (G4) connection cable	GT01-C30R4-25P	3 m	-	QnA/ACPU/motion CPU (A series)/FXCPU ⇔ GOT RS-422 connector conversion cable (FA-CNV□CBL) ⇔ GOT Serial communication module ⇔ GOT Peripheral connection module (AJ65BT-G4-S3) ⇔ GOT [D-sub 25-pin ⇔ D-sub 9-pin]
		GT01-C100R4-25P	10 m		
		GT01-C200R4-25P	20 m		
		GT01-C300R4-25P	30 m		
	Computer link connection cable	GT09-C30R4-6C	3 m	○	Serial communication module ⇔ GOT Computer link module ⇔ GOT [Separate wire ⇔ D-sub 9-pin]
		GT09-C100R4-6C	10 m		
		GT09-C200R4-6C	20 m		
GT09-C300R4-6C		30 m			
RS-232 cable	Q/LCPU direct connection cable	GT01-C30R2-6P	3 m	-	Q/LCPU ⇔ GOT L6ADP-R2 ⇔ GOT/personal computer (GT SoftGOT2000) [MINI-DIN 6-pin ⇔ D-sub 9-pin]
	FXCPU communication expansion board connection cable, FXCPU communication special adapter connection cable	GT01-C30R2-9S	3 m	-	FXCPU communication expansion board ⇔ GOT/personal computer (GT SoftGOT2000) FXCPU communication special adapter ⇔ GOT/personal computer (GT SoftGOT2000) [D-sub 9-pin ⇔ D-sub 9-pin]
	Computer link connection cable, CC-Link (G4) connection cable	GT09-C30R2-9P	3 m	○	Serial communication module ⇔ GOT Computer link module ⇔ GOT Peripheral connection module (AJ65BT-R2N) ⇔ GOT [D-sub 9-pin ⇔ D-sub 9-pin]
USB cable	Data transfer cable	GT09-C30USB-5P	3 m	○	Personal computer (screen design software) ⇔ GOT Personal computer (GT SoftGOT2000) ⇔ QnU/L/FXCPU [USB-A ⇔ USB Mini-B]

*1 FA-LTBGT2R4CBL□, FA-CNV240□CBL are developed by Mitsubishi Electric Engineering Company Limited and sold through your local sales office. The other products listed are developed by Mitsubishi Electric Systems & Service Co., LTD. and sold through your local sales office.

Connectable model list

In addition to various built-in functions, direct connection between Mitsubishi Electric industrial devices will improve productivity and reduce costs.

Programmable controller

MELSEC iQ-R SERIES MELSEC iQ-F SERIES



Servo

MITSUBISHI SERVO AMPLIFIERS & MOTORS MELSERVO



Inverter



Main connectable products (programmable controllers) of other companies

Manufacturer	Series/Model name		GS21-W-N				
			Serial communication connection		Direct CPU connection (serial)		Ethernet connection
			RS-422/485	RS-232	RS-422/485	RS-232	
KEYENCE CORPORATION	KV Nano	KV-N24□□ / KV-N40□□ / KV-N60□□ / KV-NC32T	○	○	×	○	○
		KV-N14□□	○	○	×	○	×
	KV-700		○	○	×	○	○
	KV-1000		○	○	×	○	○
	KV-3000		○	○	×	○	○
	KV-5000	KV-5500 / KV-5000	○	○	×	×	○
	KV-7000	KV-7500 / KV-7300	○	○	×	○	○
	KV-8000		○	○	×	×	○
OMRON Corporation	SYSMAC CJ1	CJ1H	○	○	×	○	○ ^{*2}
		CJ1G	○	○	×	○	○ ^{*2}
		CJ1M	○	○	×	○	○ ^{*2}
	SYSMAC CJ2	CJ2H	○	○	×	○	○ ^{*2}
		CJ2M	○	○	×	○ ^{*1}	○ ^{*2}
	SYSMAC CP1	CP1H	○	○	×	×	×
		CP1L	○	○	×	×	×
		CP1E(N type) ^{*3}	○	○	×	○	×
	SYSMAC CP2	CP2E-E	○	○	×	○	○
		CP2E-S	○	○	×	○	○
		CP2E-N	○	○	×	○	○
	NJ	NJ501-1500 / NJ501-1400 / NJ501-1300 / NJ501-1520 / NJ501-1420 / NJ501-1320 / NJ501-1340	×	×	×	×	○
		NJ301-1200 / NJ301-1100	×	×	×	×	○
NJ101-1000 / NJ101-9000 / NJ101-1020 / NJ101-9020		×	×	×	×	○	
NX	NX1P2-1140DT / NX1P2-1140DT1 / NX1P2-1040DT / NX1P2-1040DT1 / NX1P2-9024DT / NX1P2-9024DT1	×	×	×	×	○	
	NX701-1700 / NX701-1600	×	×	×	×	○	
	NX102-1200 / 1100 / 1000 / 9000	×	×	×	×	○	
Panasonic Industrial Devices SUNX Co., Ltd.	FP0		×	×	×	○	×
	FP1		×	○	×	○	×
	FP2		×	○	×	○	×
	FP3		×	○	×	○	×
	FP5		×	○	×	○	×
	FP10		×	○	×	○	×
	FP-M		×	×	×	○	×
	FPΣ		×	×	×	○	×
	FP-X		○	○	×	○	×
	FP7		○	○	×	○	×
	FP0H		×	×	×	○	×
FP-XH		×	×	○	○	×	
Siemens AG	SIMATIC S7-200 series		×	×	×	○	○ ^{*4}
	SIMATIC S7-200 SMART series		×	×	×	○	○ ^{*4}
	SIMATIC S7-200 CN series		×	×	×	○	×
	SIMATIC S7-300 series		×	×	×	○	○ ^{*5}
	SIMATIC S7-400 series		×	×	×	○	○ ^{*5}
	SIMATIC S7-1200 series		×	×	×	×	○ ^{*4}
	SIMATIC S7-1500 series		×	×	×	×	○ ^{*4}

*1 The direct CPU connection (serial) is available for CJ2M-CPU1□ only.

*2 Duplex Ethernet is not supported.

*3 For CP1E (N type) CPU module with 20 or less I/O points, only the direct CPU connection (serial) is available.

*4 Only OP communication can be used in the Ethernet connection of the S7-200 series, S7-200 SMART series, S7-1200 series, and S7-1500 series.

*5 Only OP communication can be used.

For details on connection, refer to the following "GOT2000 Series Connection Manual".

■ Mitsubishi Electric Products (SH-081197ENG)

■ Non-Mitsubishi Electric Products 1 (SH-081198ENG)

■ Non-Mitsubishi Electric Products 2 (SH-081199ENG)

■ Microcomputers, MODBUS/Fieldbus Products, Peripherals (SH-081200ENG)



Global FA Centers

Asia-Pacific

Shanghai FA Center

Mitsubishi Electric Automation (China) Ltd.
Shanghai FA Center
 Mitsubishi Electric Automation Center, No.1386
 Hongqiao Road, Shanghai, China
 Tel: +86-21-2322-3030 / Fax: +86-21-2322-3000(9611#)

Beijing FA Center

Mitsubishi Electric Automation (China) Ltd.
Beijing FA Center
 5/F, ONE INDIGO, 20 Jiuxianqiao Road Chaoyang
 District, Beijing, China
 Tel: +86-10-6518-8830 / Fax: +86-10-6518-2938

Tianjin FA Center

Mitsubishi Electric Automation (China) Ltd.
Tianjin FA Center
 Room 3203, 3204-B, City Tower, No.35, Youyi Road, Hexi
 District, Tianjin, China
 Tel: +86-22-2813-1015 / Fax: +86-22-2813-1017

Shenzhen FA Center

Mitsubishi Electric Automation (China) Ltd.
Shenzhen FA Center
 Level 8, Galaxy World Tower B, 1 Yabao Road, Longgang
 District, Shenzhen, China
 Tel: +86-755-2399-8272 / Fax: -

Guangzhou FA Center

Mitsubishi Electric Automation (China) Ltd.
Guangzhou FA Center
 Rm.1006, A1Times E-PARK, No.276-282, Hanxi Road East,
 Zhongcun Street, Panyu District, Guangzhou, China
 Tel: +86-20-8923-6730 / Fax: +86-20-8923-6715

Taipei FA Center

Mitsubishi Electric Automation (TAIWAN) Co., Ltd.
 3F, No.105, Wugong 3rd Road, Wugu District,
 New Taipei City 248019, Taiwan
 Tel: +886-2-2299-9917 / Fax: +886-2-2299-9963

Korea FA Center

Mitsubishi Electric Automation Korea Co., Ltd.
 8F, Gangseo Hangang Xi-tower A, 401,
 Yangcheon-ro, Gangseo-Gu, Seoul 07528, Korea
 Tel: +82-2-3660-9632 / Fax: +82-2-3664-0475

ASEAN FA Center

Mitsubishi Electric Asia Pte. Ltd.
 307 Alexandra Road, Mitsubishi Electric Building,
 Singapore 159943
 Tel: +65-6470-2475 / Fax: +65-6476-7439

Malaysia FA Center

Mitsubishi Electric Sales Malaysia Sdn. Bhd.
 Lot 11, Jalan 51A/219, Seksyen 51A, 46100 Petaling Jaya,
 Selangor Darul Ehsan, Malaysia
 Tel: +60-3-7626-5080 / Fax: +60-3-7658-3544

Indonesia FA Center

PT. Mitsubishi Electric Indonesia Cikarang Office
 Jl. Kenari Raya Blok G2-07A Delta Silicon 5,
 Lippo Cikarang - Bekasi 17550, Indonesia
 Tel: +62-21-2961-7797 / Fax: +62-21-2961-7794

Hanoi FA Center

Mitsubishi Electric Vietnam Co., Ltd.
Hanoi Branch Office
 14 Floor, Capital Tower, 109 Tran Hung Dao Str., Cua Nam
 Ward, Hoan Kiem Dist., Ha Noi, Vietnam
 Tel: +84-24-3937-8075 / Fax: +84-24-3937-8076

Ho Chi Minh FA Center

Mitsubishi Electric Vietnam Co., Ltd.
 11th & 12th Floor, Viettel Tower B, 285 Cach Mang
 Thang 8 Street, Ward 12, District 10, Ho Chi Minh City,
 Vietnam
 Tel: +84-28-3910-5945 / Fax: +84-28-3910-5947

Thailand FA Center

Mitsubishi Electric Factory Automation (Thailand) Co., Ltd.
 101, True Digital Park Office, 5th Floor, Sukhumvit Road,
 Bang Chak, Prakanong, Bangkok, Thailand
 Tel: +66-2682-6522-31 / Fax: +66-2682-6020

Philippines FA Center

MELCO Factory Automation Philippines Inc.
 128, Lopez-Rizal St. Brgy. Highway Hills,
 Mandaluyong City, MM, Philippines
 Tel: +63-(0)2-8256-8042 / Fax: -

India Pune FA Center

Mitsubishi Electric India Pvt. Ltd.
Pune Branch
 Emerald House, EL-3, J Block, M.I.D.C., Bhosari,
 Pune - 411026, Maharashtra, India
 Tel: +91-20-2710-2000 / Fax: +91-20-2710-2100

India Gurgaon FA Center

Mitsubishi Electric India Pvt. Ltd.
Gurgaon Head Office
 Plot 517, Ground floor, Udyog Vihar Phase 3,
 Gurugram 122008, Haryana, India
 Tel: +91-124-463-0300 / Fax: +91-124-463-0399

India Bangalore FA Center

Mitsubishi Electric India Pvt. Ltd.
Bangalore Branch
 Prestige Emerald, 6th Floor, Municipal No.2,
 Madras Bank Road, Bangalore - 560001, Karnataka, India
 Tel: +91-80-4020-1600 / Fax: +91-80-4020-1699

India Chennai FA Center

Mitsubishi Electric India Pvt. Ltd.
Chennai Branch
 Citilights Corporate Centre No.1, Vivekananda
 Road, Srinivasa Nagar, Chetpet, Chennai - 600031,
 Tamil Nadu, India
 Tel: +91-44-4554-8772 / Fax: +91-44-4554-8773

India Ahmedabad FA Center

Mitsubishi Electric India Pvt. Ltd.
Ahmedabad Branch
 B/4, 3rd Floor, SAFAL Profitaire, Corporate Road,
 Prahaladnagar, Satellite, Ahmedabad - 380015,
 Gujarat, India
 Tel: +91-79-6512-0063 / Fax: -

India Coimbatore FA Center

Mitsubishi Electric India Pvt. Ltd.
Coimbatore Branch
 BMH Srinivas, 2nd Floor, Door No.1604, Trichy Road,
 Near ICICI Bank, Coimbatore - 641018, Tamil Nadu, India
 Tel: +91-422-438-5606 / Fax: -

Americas

North America FA Center

Mitsubishi Electric Automation, Inc.
 500 Corporate Woods Parkway, Vernon Hills, IL 60061,
 U.S.A.
 Tel: +1-847-478-2100 / Fax: +1-847-478-2253

Mexico FA Center

Mitsubishi Electric Automation, Inc.
Queretaro Office
 Parque Tecnológico Innovacion Queretaro Lateral
 Carretera Estatal 431, Km 2+200, Lote 91
 Modulos 1 y 2 Hacienda la Machorra, CP 76246,
 El Marques, Queretaro, Mexico
 Tel: +52-442-153-6014 / Fax: -

Mexico City FA Center

Mitsubishi Electric Automation, Inc.
Mexico Branch
 Boulevard Miguel de Cervantes Saavedra 301, Torre Norte
 Piso 5, Int. 502, Ampliacion Granada, Miguel Hidalgo,
 Ciudad de Mexico, Mexico, C.P.11520
 Tel: +52-55-3067-7500/ Fax: -

Mexico Monterrey FA Center

Mitsubishi Electric Automation, Inc.
Monterrey Office
 Plaza Mirage, Av. Gonzalitos 460 Sur, Local 28, Col. San
 Jeronimo, Monterrey, Nuevo Leon, C.P. 64640, Mexico
 Tel: +52-55-3067-7599 / Fax: -

Brazil FA Center

**Mitsubishi Electric do Brasil Comercio e
 Servicos Ltda.**
 Avenida Adelino Cardana, 293, 21 andar, Bethaville,
 Barueri SP, Brazil
 Tel: +55-11-4689-3000 / Fax: +55-11-4689-3016

Europe

Europe FA Center

Mitsubishi Electric Europe B.V. Polish Branch
 ul. Krakowska 48, 32-083 Balice, Poland
 Tel: +48-12-347-65-00 / Fax: -

Germany FA Center

Mitsubishi Electric Europe B.V. German Branch
 Mitsubishi-Electric-Platz 1, 40882 Ratingen, Germany
 Tel: +49-2102-486-0 / Fax: +49-2102-486-7780

UK FA Center

Mitsubishi Electric Europe B.V. UK Branch
 Travellers Lane, Hatfield, Hertfordshire, AL10 8XB, U.K.
 Tel: +44-1707-27-8780 / Fax: +44-1707-27-8695

Italy FA Center

Mitsubishi Electric Europe B.V. Italian Branch
 Campus, Energy Park Via Energy Park 14, Vimercate
 20871 (MB) Italy
 Tel: +39-039-60531 / Fax: +39-039-6053-312

Czech Republic FA Center

Mitsubishi Electric Europe B.V. Czech Branch
 Pekarska 621/7, 155 00 Praha 5, Czech Republic
 Tel: +420-734-402-587 / Fax: -

Turkey FA Center

Mitsubishi Electric Turkey Elektrik Urunleri A.S.
 Serifali Mahallesi Kale Sokak No:41 Umraniye / Istanbul,
 Turkey
 Tel: +90-216-969-2500 / Fax: +90-216-661-4447

GOT2000 Series



In addition to our GOT SIMPLE Series, we also offer the feature-rich GOT2000 Series, which thrives in a variety of industrial contexts.



GOT2000

Graphic Operation Terminal

Designed to meet your industrial needs

For the details, please refer to the Mitsubishi Graphic Operation Terminal GOT2000 Series Catalog (L(NA)08270ENG).



The Mitsubishi Electric Graphic Operation Terminal GOT2000 Series continues to impress with solutions that fulfill all demands

The GOT2000 boasts advanced functionality, acts as a seamless gateway to other industrial automation devices, all while increasing productivity and efficiency. The high quality display is designed to optimize operator control and monitoring of device and line statuses. If you are looking for an intuitive operation terminal. the new tablet-like operability and the higher functionality of operation terminal makes the GOT2000 the ideal choice. Incorporate the GOT2000 to bring forth flexibility, productivity, and quality on a global scale.

FUTURE MANUFACTURING

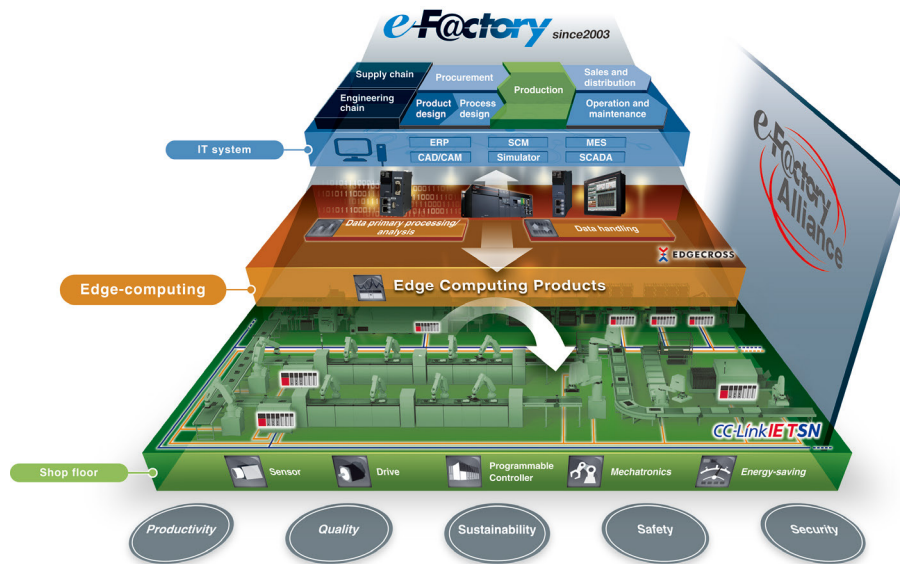

The Future of Manufacturing as envisioned by Mitsubishi Electric, e-F@ctory: “Manufacturing” that evolves in response to environmental changes in an IoT enabled world.

Established In 2003, e-F@ctory created a Kaizen^{#1} automation methodology to help optimize and manage the increasingly complex business of “manufacturing”. Continuously evolving itself, it also utilizes the expanded reach of IT, which has brought “cyber world” benefits of analysis, simulation and virtual engineering, and yet has also placed greater demands on the “physical” world for increased data sensing, collection and communication. The continued success of e-F@ctory comes from understanding that each manufacturer has individual needs and investment plans but must still deliver; “Reduced management costs” (TCO); production flexibility to make a multitude of product in varying quantities; continuously enhanced quality. In short e-F@ctory’s goal is to deliver operational performance that is “a step ahead of the times”, while enabling manufacturing to evolve in

response to its environment. To do this it is supported by three key elements:

- The e-F@ctory Alliance Partners; who bring a wide range of software, devices, and system integration skills that enable the creation of the optimal e-F@ctory architecture.
- Advanced communication; utilizing open network technology like CC-Link IE, and communication middleware such as OPC, to open the door to device data, including legacy systems, while supporting high speed extraction.
- Platform thinking; to reduce the number of complex interfaces making it easier to bring together Robotics, Motion, Open programming languages (C language), PACs etc. strengthening the field of control, yet operating on industrial strength hardware.



Kaizen^{#1} = continuous improvement
TCO = Total Cost of Ownership



Trademarks and registered trademarks

Android, Google Chrome, Google Play, and Google Play logo are trademarks of Google LLC.

MELSEC, MELSOFT, GOT, CC-Link, CC-Link IE are either trademarks or registered trademarks of Mitsubishi Electric Corporation in Japan and other countries.

MODBUS is a registered trademark of SCHNEIDER ELECTRIC USA, INC.

Safari is a trademark of Apple Inc., registered in the U.S. and other countries.

SD and SDHC Logos are registered trademarks or trademarks of SD-3C, LLC.

VNC is a registered trademark of RealVNC Ltd. in the United States and other countries.

Windows is a trademark of Microsoft Corporation.

iOS is the name of Apple Inc.'s operating system.

IOS is a registered trademark or trademark of Cisco Systems, Inc. or its affiliates in the United States and other countries, and is used under license.

App Store is a service mark of Apple Inc.

Apple, Apple logo, iPad, and iPhone are trademarks of Apple Inc. registered in the United States and other countries.

Other product and company names are either trademarks or registered trademarks of their respective owners

The actual color may differ slightly from the pictures in this catalog.

The actual display may differ from what are shown on GOT screen images.

Precautions before use

This publication explains the typical features and functions of the products herein and does not provide restrictions or other information related to usage and module combinations. Before using the products, always read the product user manuals. Mitsubishi Electric will not be held liable for damage caused by factors found not to be the cause of Mitsubishi Electric; opportunity loss or lost profits caused by faults in Mitsubishi Electric products; damage, secondary damage, or accident compensation, whether foreseeable or not, caused by special factors; damage to products other than Mitsubishi Electric products; or any other duties.

For safe use

- To use the products given in this publication properly, always read the relevant manuals before beginning operation.
- The products have been manufactured as general-purpose parts for general industries, and are not designed or manufactured to be incorporated in a device or system used in purposes related to human life.
- Before using the products for special purposes such as nuclear power, electric power, aerospace, medicine or passenger-carrying vehicles, consult with Mitsubishi Electric.
- The products have been manufactured under strict quality control. However, when installing the products where major accidents or losses could occur if the products fail, install appropriate backup or fail-safe functions in the system.

Creating Solutions Together.



Low-voltage Power Distribution Products



Transformers, Med-voltage Distribution Products



Power Monitoring and Energy Saving Products



Power (UPS) and Environmental Products



Compact and Modular Controllers



Servos, Motors and Inverters



Visualization: HMIs



Edge Computing Products



Numerical Control (NC)



Collaborative and Industrial Robots

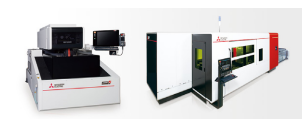

Processing machines: EDM, Lasers



SCADA, analytics and simulation software

Mitsubishi Electric's product lineup, from various controllers and drives to energy-saving devices and processing machines, all help you to automate your world. They are underpinned by software, innovative data monitoring, and modelling systems supported by advanced industrial networking and Edgecross IT/OT connectivity. Together with a worldwide partner ecosystem, Mitsubishi Electric factory automation (FA) has everything to make IoT and Digital Manufacturing a reality.

With a complete portfolio and comprehensive capabilities that combine synergies with diverse business units, Mitsubishi Electric provides a one-stop approach to how companies can tackle the shift to clean energy and energy conservation, carbon neutrality and sustainability, which are now a universal requirement of factories, buildings, and social infrastructure.

We at Mitsubishi Electric FA are your solution partners waiting to work with you as you take a step toward the realization of sustainable manufacturing and society through the application of automation. Let's automate the world together!

American Offices

USA Mitsubishi Electric Automation, Inc. 500 Corporate Woods Parkway, Vernon Hills, IL 60061, U.S.A. Tel: +1-847-478-2100	Mexico Mitsubishi Electric Automation, Inc. Mexico Branch Boulevard Miguel de Cervantes Saavedra 301, Torre Norte Piso 5, Int. 502, Ampliacion Granada, Miguel Hidalgo, Ciudad de Mexico, Mexico, C.P.11520 Tel: +52-55-3067-7500	Brazil Mitsubishi Electric do Brasil Comercio e Servicos Ltda. Avenida Adelino Cardana, 293. 21.o andar, Bethaville, Barueri SP, Brazil Tel: +55-11-4689-3000
--	---	--

Asia-Pacific Offices

China Mitsubishi Electric Automation (China) Ltd. Mitsubishi Electric Automation Center, No.1386 Hongqiao Road, Shanghai, China Tel: +86-21-2322-3030	Taiwan Mitsubishi Electric Automation (TAIWAN) Co., Ltd 6F, No.105, Wugong 3rd Road, Wugu District, New Taipei City 248019, Taiwan Tel: +886-2-2299-2499	Korea Mitsubishi Electric Automation Korea Co., Ltd. 7F to 9F, Gangseo Hangang Xi-tower A, 401, Yangcheon-ro, Gangseo-Gu, Seoul, Korea Tel: +82-2-6103-9460
Singapore Mitsubishi Electric Asia Pte. Ltd. 307 Alexandra Road, Mitsubishi Electric Building, Singapore 159943 Tel: +65-6473-2486	Malaysia Mitsubishi Electric Sales Malaysia Sdn. Bhd. Lot 11, Jalan 51A/219, Seksyen 51A, 46100 Petaling Jaya, Selangor Darul Ehsan, Malaysia Tel: +60-3-7626-5000	Indonesia PT. Mitsubishi Electric Indonesia Gedung Jaya 8th Floor, JL. MH. Thamrin No.12, Jakarta Pusat 10340, Indonesia Tel: +62-21-3192-6461
Vietnam Mitsubishi Electric Vietnam Co., Ltd. 11th & 12th Floor, Viettel Tower B, 285 Cach Mang Thang Tam Street, Ward 12, District 10, Ho Chi Minh City, Vietnam Tel: +84-28-3910-5945	Thailand Mitsubishi Electric Factory Automation (Thailand) Co., Ltd. 101, True Digital Park Office, 5th Floor, Sukhumvit Road, Bang Chak, Prakanong, Bangkok, Thailand Tel: +66-2092-8600	Philippines MELCO Factory Automation Philippines Inc. 128, Lopez-Rizal St. Brgy. Highway Hills, Mandaluyong City, MM, Philippines Tel: +63-(0)2-8256-8042
India Mitsubishi Electric India Pvt. Ltd. Pune Branch ICC-Devi Gaurav Technology Park, Unit no. 402, Fourth Floor, Survey no. 191-192 (P), Opp. Vallabh Nagar Bus Depot, Pune - 411018, Maharashtra, India Tel: +91-20-4624-2100	Australia Mitsubishi Electric Australia Pty. Ltd. 348 Victoria Road, P.O. Box 11, Rydalmere, N.S.W. 2116, Australia Tel: +61-2-9684-7777	

European Offices

Germany Mitsubishi Electric Europe B.V. German Branch Mitsubishi-Electric-Platz 1, 40882 Ratingen, Germany Tel: +49-2102-486-0	UK Mitsubishi Electric Europe B.V. UK Branch Travellers Lane, UK-Hatfield, Hertfordshire, AL10 8XB, U.K. Tel: +44-1707-28-8780	Italy Mitsubishi Electric Europe B.V. Italian Branch Campus, Energy Park Via Energy Park 14, Vimercate 20871 (MB) Italy Tel: +39-039-60531
Spain Mitsubishi Electric Europe B.V. Spanish Branch Carretera de Rubi 76-80-Appdo. 420, E-08174 Sant Cugat del Valles (Barcelona), Spain Tel: +34-935-65-3131	France Mitsubishi Electric Europe B.V. French Branch 2, rue de l'Union-92565 Rueil-Malmaison Cedex-France Tel: +33-1-55-68-55-68	Czech Republic Mitsubishi Electric Europe B.V. Czech Branch, Prague Office Pekarska 621/7, 155 00 Praha 5, Czech Republic Tel: +420-734-402-587
Turkey Mitsubishi Electric Turkey Elektrik Urunleri A.S. Serifali Mah. Kale Sok. No:41 Umraniye / Istanbul, Turkey Tel: +90-216-969-2500	Poland Mitsubishi Electric Europe B.V. Polish Branch ul. Krakowska 48, 32-083 Balice, Poland Tel: +48-12-347-65-00	South Africa Adroit Technologies 20 Waterford Office Park, 189 Witkoppen Road, Fourways, South Africa Tel: +27-11-658-8100

The release date varies depending on the product and your region. For details, please contact your local sales office.

MITSUBISHI ELECTRIC CORPORATION

HEAD OFFICE: TOKYO BLDG., 2-7-3, MARUNOUCHI, CHIYODA-KU, TOKYO 100-8310, JAPAN
 NAGOYA WORKS: 1-14, YADA-MINAMI 5, HIGASHI-KU, NAGOYA, JAPAN